



Space project management

Configuration management

Published by: ESA Publications Division
ESTEC, P.O. Box 299,
2200 AG Noordwijk,
The Netherlands

ISSN: 1028-396X

Price: € 20

Printed in: The Netherlands

Copyright: ©2005 by the European Space Agency for the members of ECSS

Foreword

This Standard is one of the series of ECSS Standards intended to be applied together for the management, engineering and product assurance in space projects and applications. ECSS is a cooperative effort of the European Space Agency, national space agencies and European industry associations for the purpose of developing and maintaining common standards.

Requirements in this Standard are defined in terms of what shall be accomplished, rather than in terms of how to organize and perform the necessary work. This allows existing organizational structures and methods to be applied where they are effective, and for the structures and methods to evolve as necessary without rewriting the standards.

The formulation of this Standard takes into account the existing ISO 9000 family of documents.

Significant changes between this version and the previous version are:

- Definition of configuration management processes' flow with consequent review and updating of existing requirements.
- Document restructuring to maintain correspondences between the descriptive section (clause 4) and requirement section (clause 5).
- Introduction of unique requirements identification.
- Update product life cycle versus project reviews and configuration verification.
- Statement of new requirements related to
 - configuration item selection,
 - hardware identification marking,
 - digital files and data, and
 - operational phase of a product.
- Addition of DRDs to specify the content of expected documentation.
- Provision of a configuration item selection guideline.
- Provision of comparison tables against some major international CM standards.

This Standard has been prepared by the ECSS M-40 Working Group, reviewed by the ECSS Management Panel and approved by the ECSS Steering Board.

This version B cancels and replaces ECSS-M-40A.

(This page is intentionally left blank)

Introduction

This document defines the configuration management requirements for space programmes or projects.

The document is structured into two main parts, the first part presenting the configuration management processes and the second one providing the detailed requirements.

In addition, the expected configuration management documentation is specified in the annexed document requirements definitions (DRDs).

(This page is intentionally left blank)

Contents

Foreword	3
Introduction	5
1 Scope	9
2 Normative references	11
3 Terms, definitions and abbreviated terms	13
3.1 Terms and definitions	13
3.2 Abbreviated terms	15
4 Configuration management principles	17
4.1 Configuration management process and objectives	17
4.2 Management and planning	18
4.3 Implementation of configuration management	20
5 Configuration management requirements	29
5.1 General	29
5.2 Management and planning	29
5.3 Implementation of configuration management	30
Annex A (normative) Configuration management plan DRD	39
Annex B (normative) Product tree DRD	43
Annex C (normative) Configuration item list DRD	45
Annex D (normative) Configuration item data list DRD	47

Annex E (normative) As-built configuration list DRD	49
Annex F (normative) Software configuration file (SCF) DRD	51
Annex G (normative) Configuration status accounting reports DRD	55
Annex H (normative) Change request DRD	59
Annex I (normative) Change proposal DRD	61
Annex J (normative) Request for deviation DRD	63
Annex K (normative) Request for waiver DRD	65
Annex L (informative) Configuration item selection	67
Annex M (informative) Comparison tables	69
Bibliography	87

Figures

Figure 1: Configuration management	18
Figure 2: Configuration management interface (inputs)	19
Figure 3: Configuration management interface (outputs)	19
Figure 4: Implementation of configuration management	21
Figure 5: Configuration identification	22
Figure 6: CI product tree structure	23
Figure 7: Configuration control	25
Figure 8: Project phases and baseline definitions	28

Scope

The present standard “Configuration management”, is part of a collection of ECSS Standards belonging to the Management branch.

The scope of this standard is to describe the processes and provide the requirements for managing the configuration of products within a space programme or project.

The requirements specified herein apply to, and affect the supplier and customer at all level.

When viewed from the perspective of a specific programme or project context, the requirements defined in this Standard should be tailored to match the genuine requirements of a particular profile and circumstances of a project.

NOTE Tailoring is a process by which individual requirements of specifications, standards and related documents are evaluated and made applicable to a specific programme or project by selection, and in some exceptional cases, modification of existing or addition of new requirements.
[ECSS-M-00-02A, clause 3]

(This page is intentionally left blank)

Normative references

The following normative documents contain provisions which, through reference in this text, constitute provisions of this ECSS Standard. For dated references, subsequent amendments to, or revisions of any of these publications do not apply. However, parties to agreements based on this ECSS Standard are encouraged to investigate the possibility of applying the most recent editions of the normative documents indicated below. For undated references, the latest edition of the publication referred to applies.

ECSS-P-001	Glossary of terms
ECSS-M-10	Space project management — Project breakdown structures
ECSS-M-20	Space project management — Project organization
ECSS-M-50	Space project management — Information/documentation management
ECSS-Q-20-09	Space project management — Nonconformance control system

(This page is intentionally left blank)

Terms, definitions and abbreviated terms

3.1 Terms and definitions

For the purposes of this document, the terms and definitions given in ECSS-P-001 and the following apply.

3.1.1

change control

activity for control of changes or **departures** to the product after formal approval of its **configuration baseline**

NOTE Adapted from ISO 10007.

3.1.2

class 1 change

change that affects approved technical specifications, including interfaces of the same level, and associated terms of the business agreement between a customer and his supplier

3.1.3

class 2 change

change that does not fulfil **class 1 change** criteria

3.1.4

configuration

functional or physical characteristics of a product defined in **configuration definition documents** subject to **configuration baseline**

NOTE Adapted from ISO 10007.

3.1.5

configuration baseline

approved status of requirements and design of a product at project key milestone that serves as reference for activities throughout the life cycle of the product

NOTE Adapted from ISO 10007.

3.1.6

configuration control

coordinated activities for controlling modifications to a **configuration baseline**

NOTE Request for deviations are also considered modifications to a baseline.

3.1.7

configuration control board

person or a group of persons assigned responsibility and authority to make decisions on the **configuration**

NOTE 1 This configuration control board is called dispositioning authority in ISO 10007.

NOTE 2 Relevant interested parties within and outside the organization are represented on the configuration control board.

NOTE 3 Adapted from ISO 10007.

3.1.8

configuration definition document

document that defines the physical **configuration** and establishes the item or material identification code (part or identifying number) at any level in the product structure

NOTE Adapted from ASME Y14.100.

3.1.9

configuration document

document that defines the requirements for function, design, build, production, and verification for a **configuration item**

NOTE For space projects, configuration documents can include documents relating to operation and disposal of the configuration item.

3.1.10

configuration identification

coordinated activities to establish rules for **configuration item** selection, baseline content definition, and product and document identifiers

3.1.11

configuration item

selected configured item for special configuration management purposes

NOTE A configuration item can contain other configuration item(s).

3.1.12

configuration management

activity for establishing and maintaining consistent record of the performance parameters of a product and its functional and physical characteristics compared to the product design and operational requirements

NOTE Configuration management is applied throughout the entire lifecycle of the product (i.e. development, production, deployment, operation and disposal).

3.1.13

configuration status accounting

formalized recording and reporting of product characteristics and configuration information, the status of applicable changes and **departures** and the status of their implementation

NOTE Adapted from ISO 10007.

3.1.14

configuration verification

coordinated activities to determine the conformity of the **configuration item** to its **configuration** document(s)

3.1.15

configured item

any level of product whose functional or physical characteristics are recorded in a retrievable, consistent manner

3.1.16

departure

inability of a product to meet one of its functional performance or technical requirements

NOTE 1 Two types exist:

- planned departure resulting in request for deviation, and
- unplanned departure resulting in request for waiver.

NOTE 2 Departures do not change the engineering documentation.

3.1.17

product item

element of the product tree having a unique identifier

3.1.18

technical description

technical definition in terms of documentation of a product, e.g. functional or performance, and design requirements, test and verification documentation, analyses, drawings, parts and material lists, processes and tooling.

3.2 Abbreviated terms

The following abbreviated terms are defined and used within this Standard:

Abbreviation	Meaning
ABCL	as-built configuration data list
AR	acceptance review
CAGE	commercial and government entity
CCB	configuration control board
CDR	critical design review
CI	configuration item
CIDL	configuration item data list
CM	configuration management
CP	change proposal
CR	change request
CSA	configuration status accounting
DB	design baseline
DCB	development configuration baseline
DRD	document requirements definition
DUNS	data universal numbering system
EIDP	end item data package
FCB	functional configuration baseline
FCV	functional configuration verification
H/W	hardware

ICD	interface control document
MOB	mission objective baseline
NATO	North Atlantic Treaty Organization
NCR	nonconformance report
OTS	off-the-shelf
PCB	product configuration baseline
PCV	physical configuration verification
PDR	preliminary design review
PI	product item
PMP	parts, materials and processes
PRR	preliminary requirements review
QR	qualification review
RFD	request for deviation
RFW	request for waiver
RID	review item discrepancy
SCF	software configuration file
SRR	system requirements review
S/W	software
TRR	test readiness review
TS	technical specification
WBS	work breakdown structure

Configuration management principles

4.1 Configuration management process and objectives

Configuration management is the process for establishing and maintaining a consistent record of a product's functional and physical characteristics compared to its design and operational requirements. Configuration management is applied throughout the entire life cycle of the product and allows one to:

- know at any time the technical description of a product using approved documentation;
- record and control the evolution in the technical description of a product (e.g. system and its products);
- provide traceability of the evolution of the product's technical description;
- ensure the consistency of the internal interfaces;
- verify and demonstrate to all actors that documentation is and remains the exact image of the products it describes;
- identify the current configuration baseline and the as-built configuration of a product, to record discrepancies detected during production, delivery or operation and dispositioned for further use;
- enable any actor to know the operational possibilities and limitations of each product item and, in case of nonconformance, to know which items are affected.

The main activities of the configuration management process, depicted in Figure 1, are

- management and planning, and
- implementation activities, i.e. configuration identification, control, status accounting, and verification and audit.

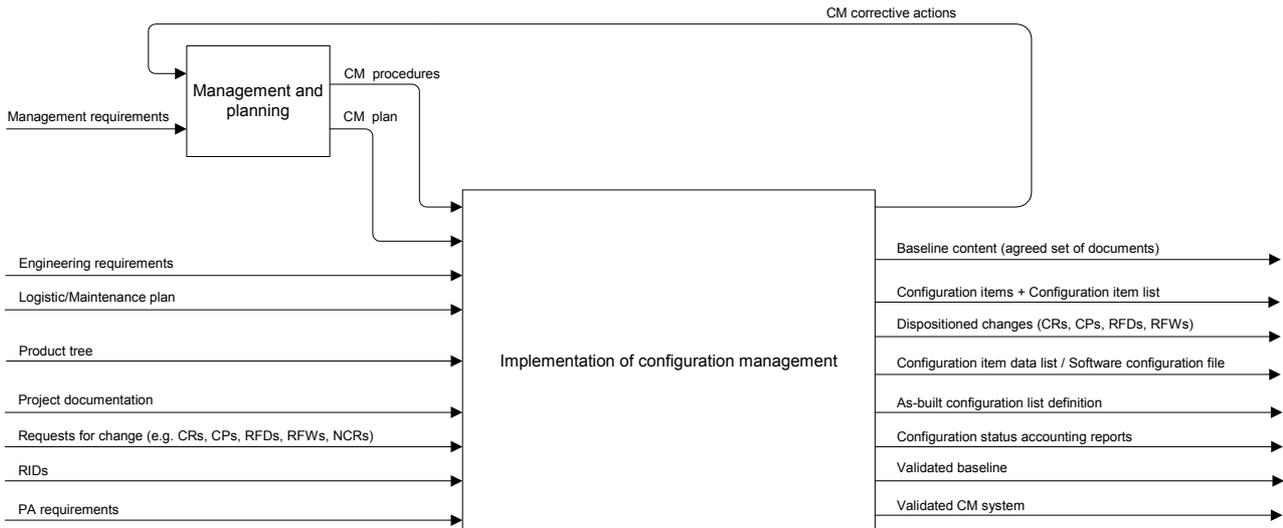

Figure 1: Configuration management

4.2 Management and planning

4.2.1 Configuration management plan

The customer defines the configuration management requirements for a programme or project. These requirements are applicable to all the actors of the programme or project as defined by the customer at each level towards his supplier(s). Each supplier produces a configuration management plan (CM plan) responding to his customer’s configuration management requirements. The CM plan is submitted to the customer for approval. Upon customer approval, the supplier executes his own CM plan and ensures that his lower tier suppliers execute their CM plan.

The purpose of the CM plan is to define the process and resources for managing the configuration of the product in a controlled and traceable manner throughout the programme or project life cycle. It also describes the means for an efficient comparison between the predicted (“as-designed”) and the actual (“as-built”) configuration of the delivered product. It defines the relationship with the project management, system engineering and quality management process.

The customer defines the programme or project phase during which the CM plan is prepared and approved.

Each actor assigns a person responsible for implementing configuration management activities within his programme or project team. His role, responsibilities and authorities are described in the CM plan.

4.2.2 Configuration management interfaces

Configuration management is an integral part of project management and interfaces with engineering, product assurance, manufacturing and production. It contributes to programme or project organization and their schedule for execution by identifying all constraints related to contractual provisions.

These are used to establish the configuration management process.

Necessary inputs for configuration management are depicted in Figure 2.

Figure 3 summarizes the products provided by configuration management to other project activities.

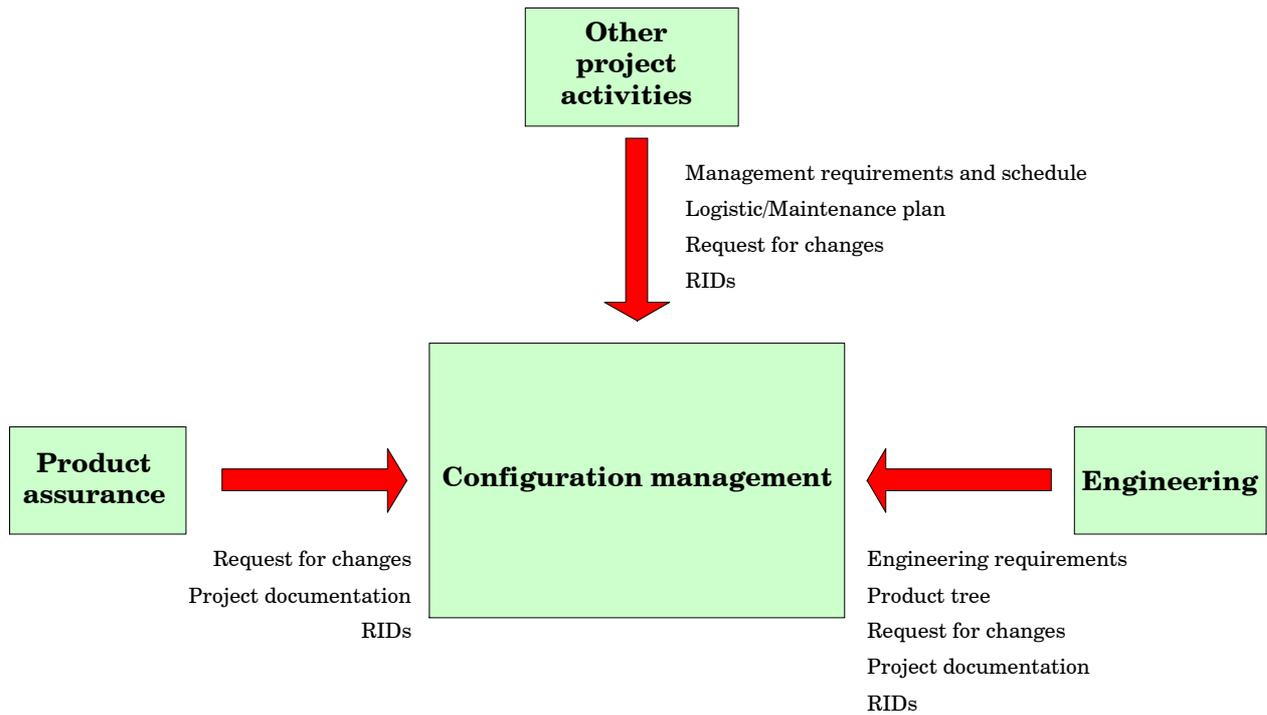

Figure 2: Configuration management interface (inputs)

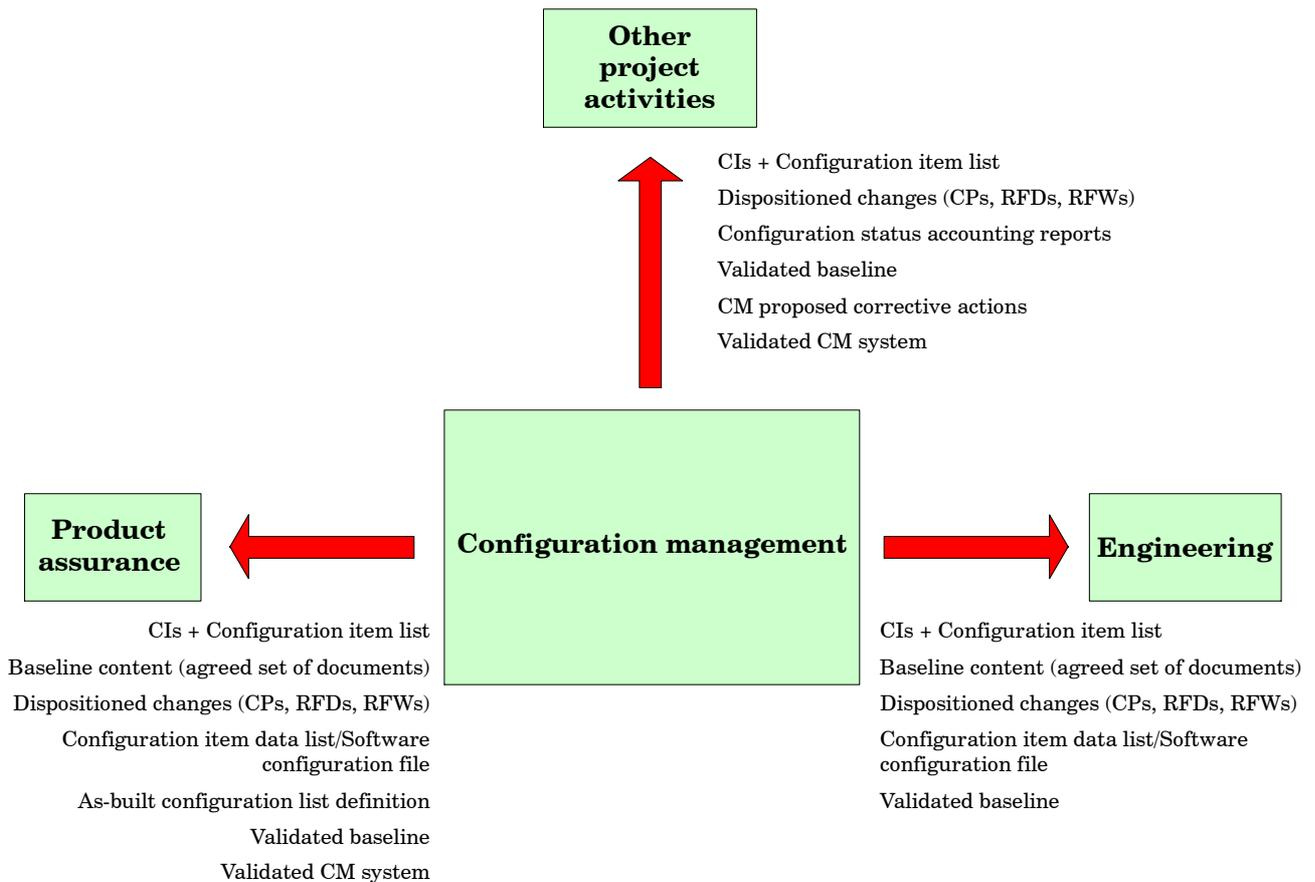

Figure 3: Configuration management interface (outputs)

4.3 Implementation of configuration management

4.3.1 General

Implementation of configuration management comprises definition, organisation, execution and supervision of the following activities, as depicted in Figure 4:

- Configuration identification
 - to identify the product architecture;
 - to select configuration items and to define their configuration documents;
 - to establish means for identifying products and documentation;
 - to define identification requirements for software media;
 - to establish configuration baselines for the purpose of requirements- and design-management.
- Configuration control
 - to establish and implement a change control process for individual products and systems, and their internal and external interfaces;
 - to record and control the configuration of a product at any time during its evolution;
 - to record the different configurations of a product;
 - to define and maintain software libraries or repositories where current and historic software baselines are stored in a controlled environment;
 - to store and maintain software products and relevant media including back-up copies in a controlled environment.
- Configuration status accounting
 - to provide a product definition by reference to approved and recorded configuration statuses;
 - to enable access to software libraries according to established privileges.
- Configuration verification and audit
 - to verify and demonstrate that the product meets its documented functional, performance and physical characteristics;
 - to verify that the configuration management system is effective and meets the programme or project configuration management requirements.

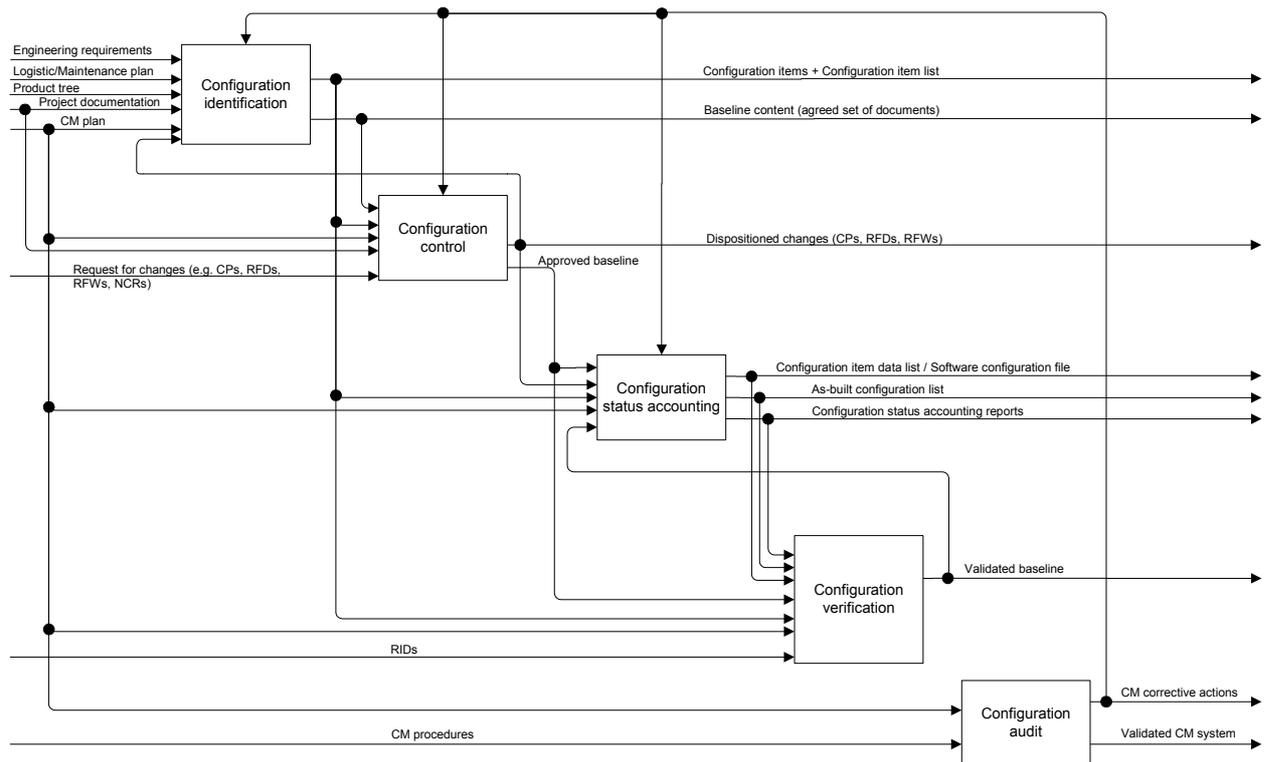

Figure 4: Implementation of configuration management

4.3.2 Configuration identification

4.3.2.1 General

Configuration identification, as depicted in Figure 5, incrementally establishes and releases controlled documentation for the purpose of identifying configuration characteristics of a product until it is fully defined with respect to its intended functional, performance and physical characteristics, thereby ensuring the continuous integrity of the product configuration.

Configuration identification also provides the basis for evolution through controlled changes and status accounting of a product throughout its life cycle. It ensures that all programme or project disciplines are provided with identical documentation for their use.

By applying product item identifiers to the product, configuration identification enables traceability from the product to its defining documentation.

The product item identifier is represented through the item identification code established by the governing configuration definition document. The product item identifier can be

- the same code applied for identifying the configuration definition document,
- a code containing this code, or
- a different code defined within the configuration definition document.

NOTE To avoid the possible existence of the same product item identifier for different product item(s), a common practice is to prefix the product item identifier with an enterprise identifier, such as a DUNS number, or NATO CAGE code.

Individual unit identification of a product can also include an additional identifier, such as a serial (or fabrication) number, or lot (or batch) number.

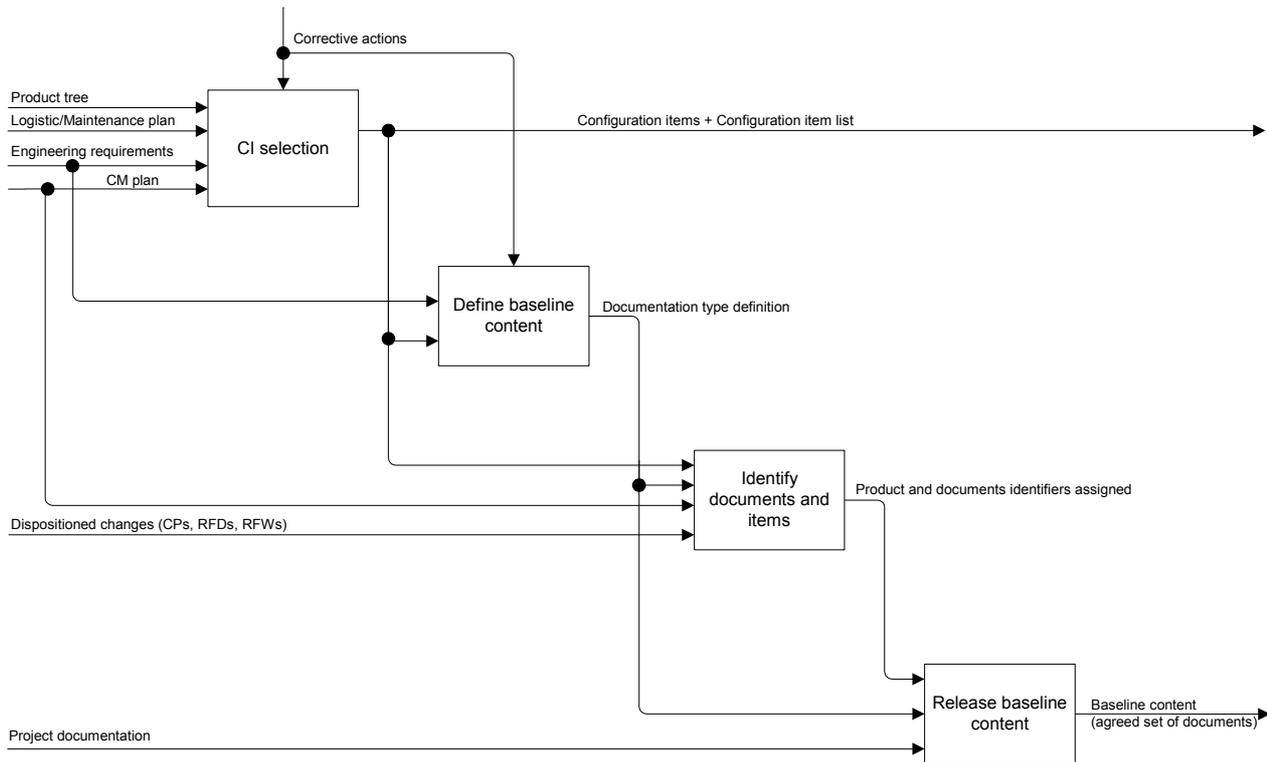

Figure 5: Configuration identification

4.3.2.2 Configuration item

Configuration items (see definition in 3.1) fall into two categories, that are:

- **Developed configuration item**

This is a configuration item subject to development and fully or partially designed for the programme or project. Its configuration management conforms to the programme or project configuration management requirements and is carried out by the supplier responsible for its development.

- **Non-developed configuration item**

This is a configuration item being a standardized or “off-the-shelf” product that is not developed specifically for the programme or project. It is subject to supplier definition documentation and configuration management. This CI category also includes any product that has been developed and qualified for another programme or project with comparable requirements and which is used without modification.

Configuration management of non-developed CIs conforms to the programme or project configuration management requirements to the extent necessary for its integration into the next higher level configuration item.

4.3.2.3 Selection of configuration items

The product tree, as defined in ECSS-M-10, is used for the selection of configuration items and serves as a basis for the programme or project work breakdown structure.

Configuration items are identified at various levels of the product tree, as depicted in Figure 6, and defined at least by a technical specification. Configuration item assignment provides the means for configuration control of the product. Each CI becomes also a configured item during its development.

Selection of configuration items starts at the early definition phase of a programme or project to build a manageable set of hardware or software items.

The responsibility for identifying an item as a CI rests with the customer, unless delegated by him to the supplier.

No fixed rules govern the selection of configuration items. The process for selecting configuration items relies on good system engineering judgment, and configuration management experience, supported by cost trade-off considerations.

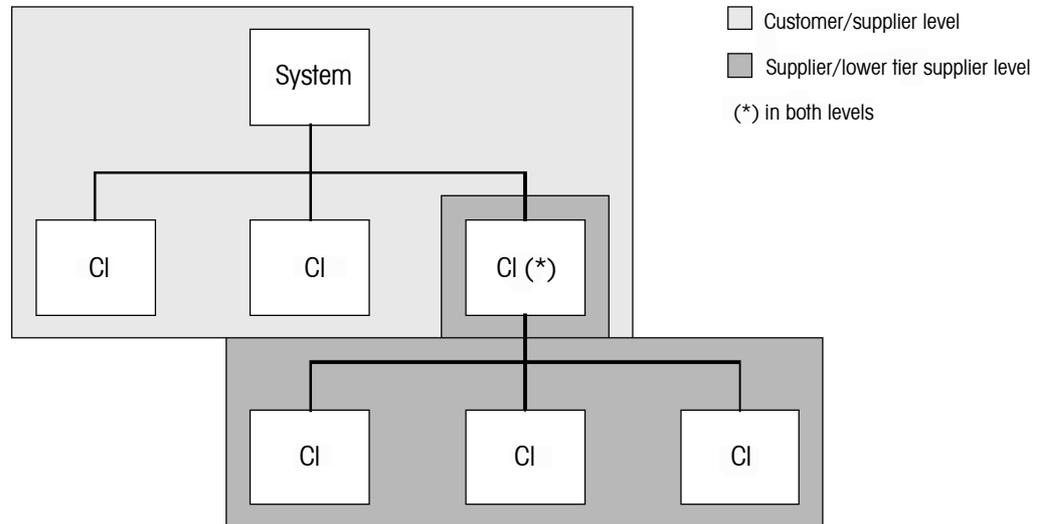

Figure 6: CI product tree structure

4.3.2.4 Configuration baseline

Configuration baselines represent the approved status of requirements and design at key milestones of the programme or project and provide the point of departure for further evolution (see Figure 8). These configuration baselines are applicable to both hardware and software.

A configuration baseline comprises the documentation that describes the characteristics of a product. This documentation is formally designated as the configuration reference at a key point in the product life cycle corresponding to a major product definition event. Any subsequent change of a product characteristic proposed for this documentation is subject to a formal change procedure involving all the actors and disciplines concerned before it can be incorporated.

During the life cycle of the product, configuration baselines are elaborated in the following sequence:

- Mission objective baseline (MOB) is established at PRR based on the approved functional specification. This baseline establishes the purpose of the system, its associated constraints and environments, the operational and performances capabilities for each phase of its life cycle, and the permissible flexibility.
- Functional configuration baseline (FCB) is established at SRR based on the approved system technical specification. This baseline establishes the system's characteristics in terms of its technical requirements, as well as the criteria and corresponding levels of qualification and acceptance.
- Development configuration baseline (DCB) is established at PDR based on approved technical specifications (TS). This baseline establishes the product's characteristics in terms of technical requirements and design constraints, as well as their verification conditions.

NOTE FCB and DCB are also named "Requirements baselines" in different standards.

- Design baseline (DB) is established at CDR based on the approved design documentation.
- Product configuration baseline (PCB) is established at FCV/PCV for serial production, or QR/AR for prototypes based on the approved set of documents containing all the functional and physical characteristics required for production, acceptance, operation, support and disposal.

The log book, as defined in ECSS-Q-20, is established at successful completion of the acceptance review and is maintained during the utilisation and disposal phases.

Details relevant to the configuration management approach during these phases are provided in subclause 4.3.7.

4.3.2.5 Identification marking

Each item, H/W and S/W is uniquely identified by a specific identification code. The identification code is assigned to a product to distinguish it during its entire life. The rules for the identification coding system are established in the CM plan.

A configured H/W item is identified by a part number and, if necessary, a serial or lot number such that every single item has a unique identifier. In this context, bulk material is treated as a part. A configured S/W item is identified by a unique code and version number. When the configured item is a configuration item, its identification also includes a CI identifier. These different product identification data are applied on the product itself or, when not possible, linked to the product.

4.3.2.6 Digital file and media identification

Configuration identification also provides the means for maintaining traceability from a product to its design definition data resident in an electronic database (digital files).

Such data, represented by digital files, are composed by a variety of subset data, which are merged in a controlled manner in order to represent the product design definition concerned in the intended configuration.

Configuration management for these sets of data and their integration into a complete product design definition is an existing application of software CM processes (e.g. library management).

Digital files defining the configuration characteristics of a product item are therefore subject to the same configuration management principles applicable to configuration documentation.

The application of configuration identification rules to digital data are applicable for

- digital data identification,
- digital data storage,
- maintenance of digital data relating to the product,
- version control of digital data and the related change management process,
- controlled access to digital data, and
- digital data transmittal.

The preservation and maintenance of digital data for product design definition throughout the programme or project life, or even as long as legal requirements specify, is addressed in ECSS-M-50.

4.3.3 Configuration control

4.3.3.1 General

Configuration control, as depicted in Figure 7, is the process for controlling the evolution of, or departures from agreed baselines. It includes the preparation, justification, evaluation, disposition and implementation of engineering and contractual changes, deviations and waivers.

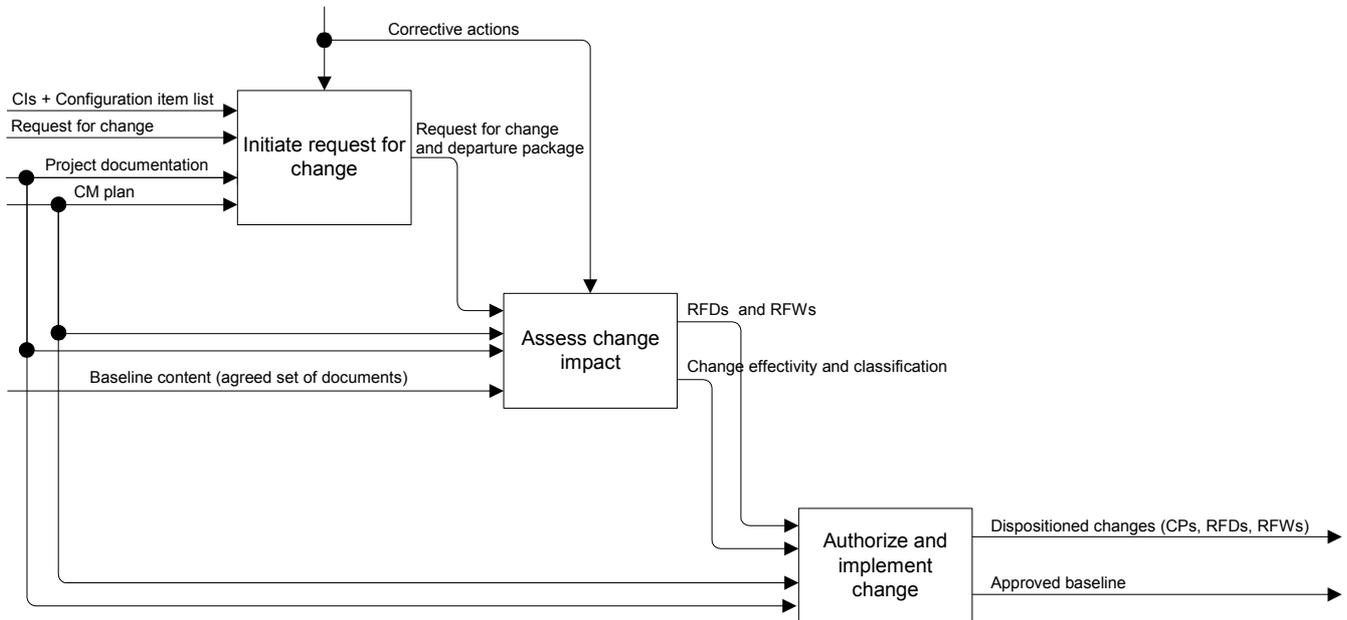

Figure 7: Configuration control

4.3.3.2 Change procedure

Configuration control ensures that all changes, deviations and waivers to agreed configuration baselines, including their released and approved documentation are processed and controlled in a traceable manner.

The configuration control process ensures that the following activities are covered:

- prevention of changes affecting degradation of product capability;
- involvement of all actors in the concerned analysis and decision process of changes;
- control that authorised changes or deviation are implemented, verified and recorded;
- prevention of the implementation of unauthorised changes or deviations.

Change control procedures are applied following the establishment of the first baseline.

All released baseline documentation, thereafter, is subject to configuration control, including submission to the customer for higher-level approval or review, as necessary. As such, no formal change can be generated without an approved baseline.

A change can be either

- initiated by the customer (e.g. evolution of requirements) followed by a reply from the supplier within a defined time limit, or
- proposed by the supplier (e.g. self-initiated improvement of design) followed by a response from the customer.

4.3.3.3 Configuration control board

Configuration control boards (CCB) are established at each project level as the relevant authority for all changes. The CCB is convened by the configuration manager in agreement with the project manager. The CCB consists of permanent representatives of all programme or project disciplines necessary for the review and evaluation of changes. The members of the CCB are with decision-making authority.

A change initiated by the customer can only be implemented after examination and approval of the supplier's response, e.g. change proposal.

4.3.3.4 Classification of changes and departures

The classification of a change or departure defines the type of approval and release cycle required according to criteria with regard to impacts on cost, schedule, technical specification and other technical or contractual characteristics.

Every change is classified by the CCB as a class I or class II change and departure as major or minor. The change or departure can be reclassified by the next higher level CCB.

According to its effects, a change proposal or a departure request is processed through the different levels of the organization. The appropriate level to decide its disposition is the level for which the effects of the change or departure have no repercussions on the commitments made to the customer. The disposition is, however, transmitted to the next-level customer for information.

4.3.3.5 Interface control

Interface control is part of the configuration control activity and defines the process necessary to freeze and implement interface data, and the control of changes affecting the interfaces. The interface control process is under the responsibility of system engineering supported by configuration management. The CM activity provides the means to identify, track and report on the status of approved interfaces.

Control of interfaces is performed through the "interface control document(s) (ICDs)", which is/are prepared to cover all aspects relevant to interfaces (e.g. mechanical, electrical, thermal and software). Configuration management provides the necessary assistance and support in recording the status of the interface data and in verifying their compliance against requirements.

4.3.4 Configuration status accounting

4.3.4.1 General

Configuration status accounting comprises the creation and organization of the knowledge base necessary for performing configuration management. It provides the source of configuration information to support all programme or project disciplines and activities through the establishment and maintenance of

- a record of approved configuration documentation (e.g. data sets) and related identification numbers,
- the status of proposed changes to and requested departures from the established configuration,
- the implementation status of approved changes and deviations, and
- the actual configuration of all units of configured items being in the operational inventory.

Together these comprise the configuration status accounting report.

4.3.4.2 As-designed and as-built data list

The CIDL is a document generated for reporting the current design status of each product configuration item. This document is provided at the PDR with the establishment of the development configuration baseline and maintained during the lifecycle of the product CI.

The CIDL itself and the data included serve as a point of departure for the control of subsequent performance, design and build changes.

When software product CIs are involved, a software configuration file is also prepared in order to provide more extensive information relevant to installation and use of the described product.

The CIDL is the source for the preparation of the ABCL, which is the document used to report the as-built and as-tested status for each serial number of product CI.

4.3.5 Configuration verification

Configuration verification is the process to verify the current configuration status of the analyzed product and results in the establishment of configuration baselines as defined in subclause 4.3.2.4. This activity is performed during programme or project reviews, which are defined in ECSS-M-30 together with their objectives.

At the end of each review, the documents and data sets that identify the current configuration baseline are updated to be in conformance with the review dispositions and then presented to the customer for approval.

4.3.6 Configuration management process audit

The effectiveness of the configuration management system is measured by audits to verify the proper application of configuration management requirements during the life cycle of the product as specified by the customer.

Audits are conducted in accordance with requirements defined in ECSS-M-20.

4.3.7 Configuration management approach for operational phase

The activities performed by configuration management during the operational phase (phase E and F of a project) are those required by the set of reviews established by ECSS-M-30.

If necessary, a dedicated CM plan can be prepared to describe the process to meet the objectives of the operational phase.

During this phase the functions of CM are continued from previous project phases.

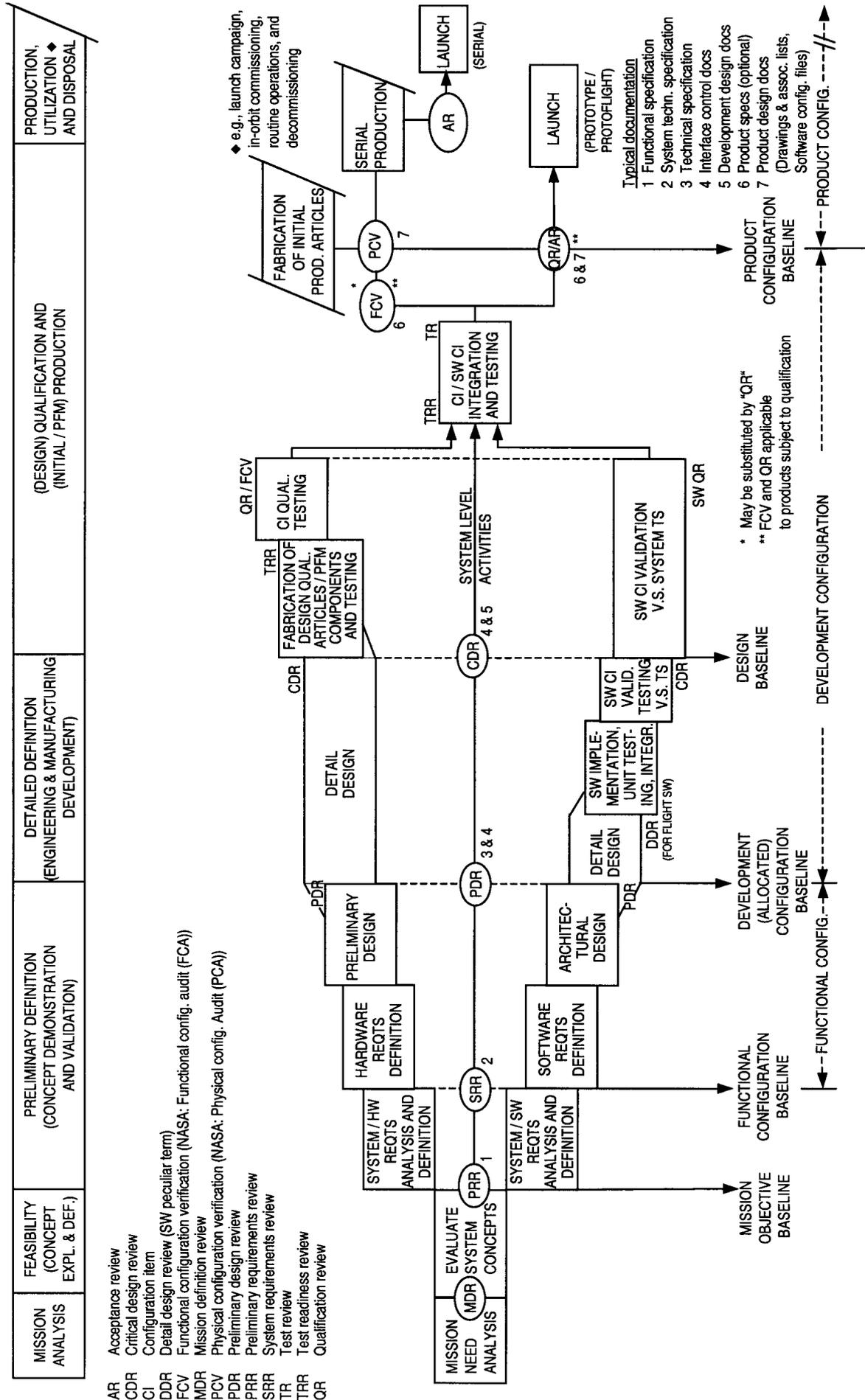

Figure 8: Project phases and baseline definitions

Configuration management requirements

5.1 General

In this ECSS Standard, in order to facilitate reading and traceability, the paragraph numbering in this clause is consistent with the paragraph numbering of clause 4. Each requirement has a unique identification number and the expected outputs are indicated in italic text.

5.2 Management and planning

5.2.1 Configuration management plan

- a. Each supplier shall provide for customer's approval a configuration management plan in conformance with Annex A, configuration management plan DRD, describing the organization, methods, means and procedure implemented for configuration management.
- b. Internal procedures implemented for configuration management called up in the configuration management plan shall be made available for customer review upon request.

EXPECTED OUTPUT: *Configuration management plan.*

5.2.2 Configuration management interfaces

- a. Configuration management processes shall interface with project management and planning, taking into account the contractual provision and schedule organization for the definition and phasing of CM activities
- b. Configuration management processes shall interface with engineering and product assurance for agreeing the technical information for which the CM process controls.
- c. Configuration management processes shall interface with logistic and maintenance processes to determine up to which level of product the CM process shall be applied.

EXPECTED OUTPUT: *Inputs for CM plan and CI list.*

5.3 Implementation of configuration management

5.3.1 Configuration identification

5.3.1.1 Product tree

- a. A product tree shall be established in conformance with ECSS-M-10 and Annex B, product tree DRD.
- b. The product tree shall be established at start of phase B and finalized not later than PDR.

EXPECTED OUTPUT: *Product tree.*

- c. The rules for product item identification shall be uniform within the programme or project.
- d. A unique identification shall be assigned to each item within the product tree.
- e. The identification shall remain unchanged during the product lifetime, unless a modification causes discontinuation of interchangeability.

EXPECTED OUTPUT: *A unique identifier for each product item.*

5.3.1.2 Configuration item

A configuration item shall be defined in relation to the following criteria:

- by its complete design documentation if it is developed for space application;
- by its procurement specification, including the list of its performances and interface characteristics, if it is an off-the-shelf (OTS) product;
- by reference to its governing standard, if it is a product defined by a standard.

EXPECTED OUTPUT: *Identification of configuration item type related baseline contents.*

5.3.1.3 Configuration item selection

- a. Based on customer input, the supplier shall identify in the product tree the configuration items and their applicable specifications, and agree these with its customer.

NOTE Detailed guideline for selecting configuration items is given in Annex L.

- b. The supplier shall prepare the list of configuration items it supplies and keep this under configuration control in conformance with Annex C, configuration item list DRD.
- c. The configuration item list shall be provided at the PDR for customer approval.

EXPECTED OUTPUT: *Configuration item list.*

5.3.1.4 Configuration baseline

- a. The supplier shall agree with its customer which documentation shall constitute each configuration baseline.

NOTE 1 For hardware products, configuration baselines include the following documents:

1. the functional specification;
2. the technical specification;
3. general specifications (e.g. environment, radiation, design rules, interfaces, and PMP);
4. procurement specification for OTS items;
5. standardization document;

6. engineering drawings (e.g. interface control drawings, parts and assembly drawings, and installation drawings) and associated lists;
7. the interface control document;
8. the configuration items data list;
9. the installation/user/operating/maintenance manual;
10. test specifications;
11. test procedures;
12. applicable engineering changes;
13. applicable deviations.

NOTE 2 For software products, configuration baselines include the following documents:

1. software system technical specification, when applicable;
 2. software requirements document (SRD);
 3. software design document;
 4. interface control document;
 5. software configuration file (SCF) (including the source code listing);
 6. software release document;
 7. the installation/user/operating/maintenance manual;
 8. the configuration description of the development tools (e.g. compilers, and linkers);
 9. software validation testing specifications;
 10. software test procedures;
 11. maintenance procedures;
 12. applicable engineering changes;
 13. applicable deviations.
- b. The baseline documentation shall reflect the actual configuration of the product, at any given point of the product life cycle.

EXPECTED OUTPUT: *Agreed documents list for configuration item baselines.*

5.3.1.5 Baseline establishment

- a. Baselines shall be established at the conclusion of each technical review as the starting point for configuration control as defined below:
 1. The starting point of configuration control for functional specification is at conclusion of the preliminary requirements review (PRR), establishing the mission objective baseline.
 2. The starting point of configuration control for system technical specifications (TS) is at conclusion of the system requirements review (SRR), establishing the functional configuration baseline.
 3. The starting point of configuration control for product technical specifications (TS) and ICDs is at conclusion of the preliminary design review (PDR), establishing the development configuration baseline. This represents freezing of performance and design requirements and control of developmental models (e.g. EM, EQM, and mock-ups).
 4. The starting point of configuration control of the product design for PFM/FM model manufacturing for qualification purposes is at the conclusion of the CDR, establishing the design baseline.
 5. The starting point of configuration control of the qualified product design for serial production is at the conclusion of the PCV, or for prototype(s) at QR/AR, establishing the product configuration baseline.
 6. The starting point of configuration control of the user manual is at conclusion of the qualification review (QR).

7. The starting point for issue and maintenance of the log book is at conclusion of the acceptance review (AR).
- b. The supplier shall maintain the configuration baselines through out the programme or project life cycle.

EXPECTED OUTPUT: *Establishment of configuration baselines.*

5.3.1.6 Identification marking

- a. Any product item shall be identified to guarantee its traceability throughout the programme or project life cycle.
- b. For developed hardware CI, the following information shall be included:
 1. CI-identifier;
 2. part number;
 3. serial or lot number;
 4. model identifier, e.g. EM, STM, and FM (not for ground systems);
 5. manufacturer identifier;
 6. product name or abbreviation.
- c. For developed software CIs, the following shall be included in the header:
 1. CI-identifier;
 2. software identifier;
 3. version and revision number;
 4. release date;
 5. manufacturer identifier;
 6. product name or abbreviation.
- d. For OTS and standard products, the following information shall be included as a minimum:
 1. part number;
 2. serial or lot number;
 3. manufacturer identifier;
 4. product name or abbreviation.
- e. All product items, not defined as configuration item, shall be marked or labelled including the following information:
 1. part number;
 2. serial or lot number, when applicable;
 3. manufacturer identifier.
- f. All product items subject to major nonconformances shall receive supplemental identification to provide a link to the departure authorisation document.
- g. For media containing software, the following information shall be included as a minimum:
 1. CI-identifier;
 2. S/W identifier;
 3. version and revision number;
 4. date of generation;
 5. manufacturer identifier;
 6. product name or abbreviation;
 7. SCF reference including issue and date;
 8. total number of delivered media per information set (1 of ...);

9. copy or serial number of data set.
- h. When the physical dimensions of the item restricts full identification marking, the following shall apply:
 1. select a minimum set of information which uniquely identifies the items;
 2. identify on a permanent tag, if possible;
 3. if permanent tag is not possible, identify on a removable tag or on the packaging.
- i. The identification marking methods applied shall be compatible with the product's operational environment, and shall be defined in the configuration definition document.
- j. Identification marking of software products shall be established through the hardware product where the software is resident (i.e. the firmware), or the media in which the software is stored.

EXPECTED OUTPUT: *Identification marking of products.*

5.3.1.7 Digital file and media identification

- a. Digital files defining configuration characteristics shall be uniquely identified and linked to their related product configuration data.
- b. The digital data files forming part of each configuration baseline shall be stored in a secure environment with controlled access.
- c. Digital files composing the definition of configuration characteristics shall be maintainable throughout the life cycle of the programme or project in conformance to ECSS-M-50.
- d. Digital files defining the configuration characteristics shall be stored within the CM system by its native code and by a PC readable file directly generated from the native code (e.g. PDF or TIFF).
- e. The system shall be able to manage check-in/check-out, multiple versions and shall be able to generate any current, baseline or past version of the file.
- f. Distribution, delivery or publishing of the file shall be generated from the master file.
- g. Paper forms of digital files shall be traceable to the master file.
- h. The order of precedence between the master file and the printed documentation shall be established.
- i. CAD data (e.g. CAD files, 3D models, and digital mock-ups) shall be traceable to the engineering drawing.

EXPECTED OUTPUT: *Digital data file identification.*

- j. Digital data media shall be identified by the following:
 - CI identifier;
 - file names;
 - version and issue;
 - date of generation;
 - generating entity;
 - total number of delivered media per information set (1 of ...).
- k. The following information shall be provided together with digital data media:
 - host system;
 - application software;
 - printer and style details;
 - special instruction for further processing of the data file.

EXPECTED OUTPUT: *Media marking identification and processing instructions.*

5.3.2 Configuration control

5.3.2.1 Change procedure

- a. A change procedure shall be established to describe the process for changing a configuration baseline.
- b. Any change to a configuration item, in relation to an approved configuration baseline, shall be described, justified and classified by the requesting party, before submission for review and disposition.
- c. Each actor shall establish a configuration control board to evaluate and approve any change to a configuration item relative to a configuration baseline.
- d. Related changes of several products resulting from a common need for change shall be processed simultaneously.
- e. Changes related to an element common to several products shall be presented to all the concerned actors for impact assessment.

EXPECTED OUTPUT: *Change procedure documented and approved evolution of the baseline.*

5.3.2.2 Classification of changes and departures

- a. A class 1 change, or a major departure, shall be approved by the customer before its implementation.
- b. A class 2 change, or a minor departure, shall be implemented after supplier approval and provided to the customer for information.
- c. Customer may reclassify the class 2 proposed changes and minor departures.
- d. Unplanned departures shall be classified and processed in conformance to ECSS-Q-20-09.
- e. Major planned departures shall be processed as for class 1 changes.
- f. Minor planned departures shall be processed as for class 2 changes.
- g. For planned departures from requirements or design, the supplier shall submit a request for deviation describing why the product concerned cannot meet requirements of the baselined configuration documentation.
- h. The supplier shall ensure that changes or departures are approved at the level for which the effects of the change or the departure can have no repercussion on the commitments made to the customer.
- i. The evaluation shall be transmitted to the customer for information.

EXPECTED OUTPUT: *Classification of changes and departures.*

5.3.2.3 Initiation of change

- a. All changes initiated by the customer shall use a change request in conformance to Annex H, change request DRD.
- b. All changes initiated by the supplier shall use a change proposal in conformance to Annex I, change proposal DRD.

EXPECTED OUTPUT: *Change request and change proposal.*

5.3.2.4 Change assessment

- a. Both customer and supplier shall establish procedures for the analysis, review and disposition of proposed changes.
- b. The change assessment shall cover all technical, programmatic and operational impacts on all affected products for which the actor is responsible.
- c. Each project actor shall assess any request or proposal for a change to a configuration baseline, which is presented to him by his customer or supplier.

EXPECTED OUTPUT: *Assessed changes.*

5.3.2.5 Change disposition

All changes shall be dispositioned by the configuration control board as either:

- approved, defining the applicability of evolution and associated implementation modes,
- rejected, with a supporting rationale, or
- deferred until additional information is provided.

EXPECTED OUTPUT: *Dispositioned changes.*

5.3.2.6 Departures from configuration baseline

- a. The supplier shall request planned departures from requirements or design using a request for deviation in conformance with Annex J, request for deviation DRD.
- b. The supplier shall request unplanned departures from requirements or design using a request for waiver in conformance with Annex K, request for waiver DRD.
- c. The configuration control board shall process deviations and shall process waivers from baselined requirements or design when customer requirements are affected.
- d. Departures shall be limited to a number of items or a period of time.
- e. Deviations related to an element common to several products shall be presented to all the concerned actors for impact assessment.

EXPECTED OUTPUT: *Departure covered by RFD or RFW.*

5.3.2.7 Baseline and documentation update

- a. Configuration baselines shall be updated in conformance with the disposition of approved changes and deviations.

EXPECTED OUTPUT: *Updated baselines.*

- b. Configuration-controlled documents shall be revised to incorporate approved changes.

EXPECTED OUTPUT: *Updated configuration controlled document.*

5.3.2.8 Interface control

- a. Each actor shall record the status of interface definition data.
- b. Each actor shall ensure that all interface definition data is consistent with its product configuration.
- c. The supplier shall identify and control the internal interfaces of its product and those interfaces for which he has received delegated authority.
- d. Configuration management shall establish, concurrently with the system engineering, the overall organization and procedures to process and manage changes to interfaces.
- e. Each actor shall clearly identify in configuration definition documentation the data subject to interface management

EXPECTED OUTPUT: *Controlled interface.*

5.3.3 Configuration status accounting

5.3.3.1 General

- a. All actors shall establish a configuration status accounting system to record, store and retrieve the following configuration data:
 1. status of the configuration baselines;
 2. design status of the configuration items;

3. as-built status of accepted products;
4. status of configuration documentation and configuration data sets;
5. status of approval of changes and deviations and their status of implementation, the status of waivers;
6. status of actions derived from technical reviews and configuration verification reviews.

EXPECTED OUTPUT: *Documented configuration status.*

- b. Each supplier shall provide configuration status accounting reports in conformance with Annex G, configuration status accounting reports DRD.

EXPECTED OUTPUT: *Configuration status accounting reports.*

5.3.3.2 As-designed data list

- a. The supplier shall provide a configuration item data list (CIDL), in conformance with Annex D, configuration item data list DRD, for each deliverable CI.
- b. For each deliverable software CI, the supplier shall provide a software configuration file (SCF) in conformance with Annex F, software configuration file DRD.
- c. A CIDL shall be available for the first design review to determine the initial configuration baseline.
- d. The complete CIDL for an individual CI, model or deliverable item shall be available at project reviews.
- e. Changes implemented after delivery of the product shall be incorporated in the CIDL and the updated CIDL shall be provided for log-book updating.

EXPECTED OUTPUT: *Configuration item data list and software configuration file for software products.*

5.3.3.3 As-built data list

- a. For each deliverable serial number of CI, the supplier shall provide an as-built configuration data list in conformance with Annex E, as-built configuration list DRD.
- b. The ABCL shall identify the “as manufactured” and “as tested” statuses applicable to parts composing a CI.
- c. Using the CIDL as a reference, any difference between the ABCL and the CIDL shall be documented in the ABCL by reference to the applicable NCR(s) or RFW(s).

EXPECTED OUTPUT: *As-built configuration list.*

5.3.4 Configuration verification

5.3.4.1 Verification of the product configuration definition

- a. At SRR, the functional configuration definition shall be verified against mission objectives.
- b. At PDR, the development configuration definition shall be verified against the applicable technical specifications.
- c. At CDR, the design definition shall be verified against the relevant design documentation.

EXPECTED OUTPUT: *Validated baseline.*

5.3.4.2 Verification of the product configuration

- a. The supplier shall perform configuration verification by systematically comparing the “as-built” configuration of a CI with its “as designed” configuration.

- b. Configuration in terms of functional and performance characteristics shall be verified at qualification review (QR) for prototype or proto-flight production, and FCV for serial production.
- c. Configuration in terms of physical and nominal performance characteristics shall be verified at AR for prototype or proto-flight production and PCV for serial production.

EXPECTED OUTPUT: *Verified product configuration baseline.*

5.3.5 Audit of the configuration management system

- a. Each project actor shall conduct internal audits to verify the application of configuration management requirements internal to his organization
- b. Each project actor shall conduct external audits to verify the application of configuration management requirements by its lower tier suppliers, in accordance with the requirements defined in ECSS-M-20.

EXPECTED OUTPUT: *Validated configuration management system.*

5.3.6 Configuration management approach for operational phase

The following product configuration related activities shall be implemented during the operational phase:

- a. Preparation of a CM plan in conformance with Annex A, configuration management plan DRD, to meet the objective of the operational phase.

NOTE This requirement can be fulfilled by adapting the development phase CM plan or creating a dedicated CM plan.

- b. Provisioning of, or access to development phase documents as established at product delivery.
- c. Maintenance and control of ground models (i.e. engineering model and mock-ups) supporting the flight operations to be flight representative.
- d. Inventory control of flight spare parts in terms of quantity and storage location.
- e. Product enhancement shall be accomplished in three different ways as follows:
 - 1. for in-line production with no retrofit to delivered units, production changes are undertaken by normal change processing;
 - 2. for in-line production with retrofitting of delivered units, retrofit changes are either carried out by the supplier on basis of contractor modification documentation; or
 - 3. retrofit of delivered units (no more production) by the user, on basis of a modification kit with accompanying modification instructions.
- f. Design change implementation on product according to the following cases:
 - 1. normal change processing for in-line production with no retrofitting of delivered product;
 - 2. documentation update for in-line production with retrofitting of delivered product performed by the supplier; or
 - 3. modification kit with accompanying modification instructions for retrofitting by the user of the product.

(This page is intentionally left blank)

Annex A (normative)

Configuration management plan DRD

A.1 DRD identification

A.1.1 Requirement identification and source document

ECSS-M-40B, requirement 5.2.1.a.

A.1.2 Purpose and objective

The objective of the configuration management plan is to provide in a single document all elements necessary to ensure that the implementation of configuration management meets customer requirements and is commensurate with the programme or project, organization, and management structure.

A.2 Expected response

A.2.1 Response identification

The requirements for document identification contained in ECSS-M-50 shall be applied to the configuration management plan.

A.2.2 Scope and content

The configuration management plan shall provide the information presented in the following sections:

<1> Introduction

The introduction shall describe the purpose and objective of the configuration management plan.

<2> Applicable and reference documents

The configuration management plan shall list the applicable and reference documents in support of the generation of the document.

<3> Management

<3.1> Organization

- a. The configuration management plan shall describe the organizational context, both technical and managerial, within which the prescribed configuration management activities shall be implemented.

- b. The configuration management plan shall also describe the interface with other CM organizations (customer relations, subcontractor or vendor management) and the CM relationship to other internal organization elements.

<3.2> Responsibilities

The configuration management plan shall describe the allocation of responsibilities and authorities for configuration management activities to organizations and individuals within the programme or project structure.

<3.3> Policies, directives and procedures

Any external constraints, or requirements, placed on the configuration management plan by other policies, directives, or procedures shall be identified in this section together with the consequences of applying these to the programme or project.

<4> Activities

<4.1> General

- a. The configuration management plan shall identify all functions and processes, both technical and managerial, required for managing the configuration of the programme or project.
- b. The configuration management plan shall introduce the following, as a minimum:
 - configuration identification;
 - configuration control;
 - configuration status accounting;
 - configuration audits and reviews;
 - interface control;
 - subcontractor or vendor control.

<4.2> Configuration identification

- a. The configuration management plan shall identify, name, and describe the documented physical and functional characteristics of the information to be maintained under configuration management control for the programme or project.
- b. The configuration management plan describe the following, as a minimum:
 - product tree establishment (System decomposition);
 - identification of configuration items, i.e. the selection process of the items to be controlled and their definitions as they evolve or are selected;
 - naming of configuration items, i.e. the specification of the identification system for assigning unique identifiers to each item to be controlled;
 - configuration baselines establishment and maintenance;
 - interface identification;
 - configuration documentation and data release procedures.
- c. In case of software configuration item and where a tool is used to build its baseline, the following shall be described:
 - procedure to enter a software configuration item into a baseline;
 - procedure to configure and establish a baseline;
 - software products and records to define a baseline;
 - procedure to approve a baseline;
 - authority to approve a baseline.

- d. In case software libraries are established, the following shall be identified:
- library types;
 - library locations;
 - media used for each library;
 - library population mechanism;
 - number of identical libraries and the mechanism for maintaining parallel contents;
 - library contents and status of each item included in;
 - conditions for entering a SCI, including the status of maturity compatible with the contents required for a particular software library type;
 - provision for protecting libraries from malicious and accidental harm and deterioration;
 - software recovery procedures;
 - conditions for retrieving any object of the library;
 - library access provisions and procedures.

<4.3> Configuration control

- a. The configuration management plan shall describe the configuration control process and data for implementing changes to the configuration items and identify the records to be used for tracking and documenting the sequence of steps for each change.
- b. The configuration management plan shall describe the following, as a minimum:
- configuration control board functions, responsibilities, authorities;
 - processing changes;
 - change requests;
 - change proposal;
 - change evaluation;
 - change approval;
 - change implementation;
 - processing planned configuration departures (deviations);
 - processing unplanned configuration departures (product nonconformances, waivers).

<4.4> Interface control

The configuration management plan shall describe the process and data for coordinating changes to the programme or project configuration management items with changes to interfaces.

<4.5> Supplier or vendor control

- a. For both subcontracted and acquired products (i.e. equipment, software or service), the configuration management plan shall define the process and data to flow down the CM requirements and the programme monitoring methods to control the supplier or vendor.
- b. The configuration management plan shall define the process and data to incorporate the supplier- or vendor-developed items into programme or project configuration management and to coordinate changes to these items.
- c. The configuration management plan shall also describe how the product is received, tested, and placed under configuration control.

<4.6> Configuration status accounting

- a. The configuration management plan shall describe the process and data for reporting the status of configuration items.
- b. The following minimum information shall be tracked and reported for each configuration management item:
 - status of the configuration baselines;
 - design status of the configuration item;
 - status of configuration documentation and configuration data sets;
 - status of approval of changes and deviations and their implementation status;
 - status of discrepancies and actions arising from technical reviews and configuration verification reviews.

<4.7> Configuration verification

- a. The configuration management plan shall describe the process and data to verify the current configuration status from which the configuration baselines are established.
- b. The configuration management plan shall provide the description of verification plans, procedures and schedules and shall identify how the recording, reporting and tracking of action items and incorporation of review recommendations are maintained.

<4.8> Audits of CM system

- a. The configuration management plan shall describe the process, data and schedule for configuration audits to ensure that the configuration management of the programme or project is performed.
- b. As a minimum, the configuration management plan shall enable that
 - the CM process is properly defined, implemented and controlled, and
 - the configuration management items reflect the required physical and functional characteristics.

<4.9> Technical data management

The configuration management plan shall describe the process and data to access and maintain text and CAD files, data and software repositories, and the implementation of any PDM system.

<5> Schedule and resources

<5.1> Schedule

The configuration management plan shall establish the sequence and coordination for all the configuration management activities and all the events affecting the CM plan's implementation.

<5.2> Resources

The configuration management plan shall identify the tools, techniques, equipment, personnel, and training necessary for the implementation of configuration management activities.

A.2.3 Special remarks

The response to this DRD may be combined with the response to the project management plan, as defined in ECSS-M-00B.

Annex B (normative)

Product tree DRD

B.1 DRD identification

B.1.1 Requirement identification and source document

ECSS-M-10B, requirement 5.3.1.

ECSS-M-40B, requirement 5.3.1.1.a.

ECSS-E-10 Part 1B, requirement 5.3.2.10.

B.1.2 Purpose and objective

The objective of the product tree document is to describe, in a single document, the hierarchical partitioning of a deliverable product down to a level agreed between the customer and supplier.

The product tree is part of the design definition file. It is the starting point for selecting configuration items (as specified in ECSS-M-40B) and establishing the work breakdown structure (as specified in ECSS-M-10B), and is a basic structure to establish specification tree (as defined in ECSS-E-10 Part 1B).

B.2 Expected response

B.2.1 Response identification

The requirements for document identification contained in ECSS-M-50 shall be applied to the product tree.

B.2.2 Scope and content

The product tree shall provide the information presented in the following sections:

<1> Introduction

The product tree shall contain a description of the purpose, objective and the reason prompting its preparation (e.g. programme or project reference and phase).

<2> Applicable and reference documents

The product tree shall list the applicable and reference documents supporting the generation of the document.

<3> Tree structure

- a. The product tree shall provide the breakdown of lower level products constituting the deliverable product.
- b. For each item identified in the product tree, the following information shall be provided:
 - identification code;
 - item name;
 - item supplier;
 - applicable specification.
- c. The product tree shall be presented either as a graphical diagram or an indented structure where the product (i.e. at the top level of the tree) is decomposed into lower level products.
- d. A product item selected as configuration item shall be identified in the product tree.
- e. When recurrent products from previous space projects are used, they shall be identified in the tree structure.

B.2.3 Special remarks

None.

Annex C (normative)

Configuration item list DRD

C.1 DRD Identification

C.1.1 Requirement identification and source document

ECSS-M-40B, requirement 5.3.1.3.b.

C.1.2 Purpose and objective

The objective of the configuration item list is to provide a reporting instrument defining the programme or project items subject to configuration management process.

C.2 Expected response

C.2.1 Response identification

The requirements for document identification contained in ECSS-M-50 shall be applied to the configuration item list.

C.2.2 Scope and content

The configuration item list shall provide the information presented in the following sections:

<1> Introduction

The introduction shall describe the purpose and objective of the configuration item list.

<2> Applicable and reference documents

The configuration item list shall list the applicable and reference documents in support to the generation of the document.

<3> List

The configuration item list shall contain for each configuration item (CI) the following information:

- identification code (derived from the product item code);
- models identification and quantity;
- CI name;

- CI category (developed, non-developed);
- CI supplier;
- applicable specification.

C.2.3 Special remarks

None.

Annex D (normative)

Configuration item data list DRD

D.1 DRD identification

D.1.1 Requirement identification and source document

ECSS-M-40B, requirement 5.3.3.2.a.

D.1.2 Purpose and objective

The configuration item data list (CIDL) is a document generated from the central database giving the current design status of a configuration item (CI), at any point of time in sufficient detail, providing its complete definition.

D.2 Expected response

D.2.1 Response identification

The requirements for document identification contained in ECSS-M-50 shall be applied to the configuration item data list.

D.2.2 Scope and content

The configuration item data list shall provide the information presented in the following sections:

<1> Introduction

The introduction shall describe the purpose and objective of the configuration item data list.

<2> Applicable and reference documents

The configuration item data list shall list the applicable and reference documents in support to the generation of the document.

<3> List

- a. The configuration item data list shall include the following:
 - Cover sheets and scope.
 - Customer controlled documentation, including
 - customer specifications and ICDs, and
 - support specifications.

- Engineering or design documentation, including
 - verification plans demonstrating compatibility with specified requirements,
 - special instructions or procedures (e.g. transportation, integration, and handling),
 - declared PMP lists,
 - lower level specifications,
 - lower level ICDs,
 - drawings and associated lists,
 - test specifications,
 - test procedures, and
 - users manual or handbook.
 - List of applicable changes not yet incorporated into the baselined documentation, and deviations (including status, directly related to the document (e.g. specification) to which the change belongs to).
 - CI number breakdown
 - indentured breakdown by part numbers starting from the part number associated with the CI down to the lowest level of composition;
 - quantity of each part number used on the next higher assembly;
 - issue status of the drawings and associated lists applicable to each part number.
- b. Each entry in the CIDL shall relate to the applicable model(s) of the CI and be defined by its document number, title, issue and release date.

D.2.3 Special remarks

None.

Annex E (normative)

As-built configuration list DRD

E.1 DRD identification

E.1.1 Requirement identification and source document

ECSS-M-40B, requirement 5.3.3.3.b.

E.1.2 Purpose and objective

The objective of the as-built configuration list (ABCL) is to provide a reporting instrument defining the as-built status per each serial number of configuration item subject to formal acceptance.

E.2 Expected response

E.2.1 Response identification

The requirements for document identification contained in ECSS-M-50 shall be applied to the as-built configuration list.

E.2.2 Scope and content

The as-built configuration list shall provide the information presented in the following sections:

<1> Introduction

The introduction shall describe the purpose and objective of the as-built configuration list.

<2> Applicable and reference documents

The as-built configuration list shall list the applicable and reference documents in support to the generation of the document.

<3> List

- a. The as-built configuration list shall list all discrepancies between the as-designed configuration documented in the configuration item data list and the as-built configuration documented by nonconformance reports or waivers.
- b. The ABCL configuration item breakdown section, obtained from the equivalent configuration item data list section, shall be completed by adding the following information:

- serial number identification;
- lot or batch number identification;
- reference(s) of applicable nonconformance report(s) or request for waiver(s).

E.2.3 Special remarks

None.

Annex F (normative)

Software configuration file (SCF) DRD

F.1 DRD identification

F.1.1 Requirement identification and source document

ECSS-M-40B, ECSS-E-40 Part 1B and ECSS-Q-80B requirements are identified in the following table:

ECSS Standard	Subclause
ECSS-M-40B	5.3.3.2.b.
ECSS-E-40 Part 1B	5.5.3.1 expected output b
ECSS-Q-80B	6.2.4.3
	6.2.4.4
	6.2.4.5
	6.2.4.6
	6.2.4.8 expected output b
	6.2.4.10
	6.2.4.12 expected output b

F.1.2 Purpose and objective

The objective of the software configuration file is to provide the configuration status of the software configuration item. It controls its evolution during the programme or project life cycle.

The SCF is a constituent of the design definition file (as defined in ECSS-E-10 Part 1B).

F.2 Expected response

F.2.1 Response identification

The requirements for project identification contained in ECSS-M-50 shall be applied to the SCF.

F.2.2 Scope and content

The SCF shall provide the information presented in the following sections:

<1> Introduction

The introduction shall describe the purpose and objective of the SCF.

<2> Applicable and reference documents

The SCF shall list the applicable and reference documents to support the generation of the document.

<3> Terms, definitions and abbreviated terms

The SCF shall include any additional terms, definition or abbreviated terms used.

<4> Software configuration item overview

- a. The SCF shall contain a brief description of the software configuration item.
- b. For the software configuration item, the following information shall be provided:
 1. how to get information about the software configuration item;
 2. composition of the software configuration item: code, documents;
 3. means to develop, modify, install, run the software configuration item;
 4. differences from the reference or previous version;
 5. status of software problem reports, software change requests, and software waivers and deviations related to the software configuration item.

<5> Inventory of materials

- a. The SCF shall list all physical media (e.g. listings, tapes, cards or disks) and associated documentation released with the software configuration item.
- b. The SCF shall define the instructions necessary to get information (e.g. files) included in physical media.

<6> Baseline documents

The SCF shall identify all the documents applicable to the delivered software configuration item version.

<7> Inventory of software configuration item

- a. The SCF shall describe the content of the software configuration item.
- b. The SCF shall list all files constituting the software configuration item:
 1. source codes with name, version, description;
 2. binary codes with name, version, description;
 3. associated data files necessary to run the software;
 4. media labelling references;
 5. checksum values;
 6. identification and protection method and tool description.

<8> Means necessary for the software configuration item

The SCF shall describe all items (i.e. hardware and software) that are not part of the software configuration item, and which are necessary to develop, modify, generate and run the software configuration item, including:

- a. items related to software development (e.g. compiler name and version, linker, and libraries);
- b. build files and software generation process;
- c. other software configuration items.

<9> Installation instructions

The SCF shall describe how to install the software configuration item version, its means and procedures necessary to install the product and to verify its installation.

<10> Change list

This SCF shall contain the list of all changes incorporated into the software configuration item version, with a cross reference to the affected software configuration item document, if any. Changes not incorporated yet but affecting the S/W CI shall also be listed. This list shall include:

- a. software problem reports;
- b. software change requests and proposals;
- c. contractual change notices;
- d. software waivers and deviations.

<11> Auxiliary information

The SCF shall include any auxiliary information to describe the software configuration.

<12> Possible problems and known errors

The SCF shall identify any possible problems or known errors with the software configuration item version and any steps being taken to resolve the problems or errors.

F.2.3 Special remarks

None.

(This page is intentionally left blank)

Annex G (normative)

Configuration status accounting reports DRD

G.1 DRD identification

G.1.1 Requirement identification and source document

ECSS-M-40B, requirement 5.3.3.1.b.

G.1.2 Purpose and objective

The purpose of configuration status accounting reports is to provide a reliable source of configuration information to support all programme or project activities. They provide the knowledge base necessary for performing configuration management.

G.2 Expected response

G.2.1 Response identification

The requirements for document identification contained in ECSS-M-50 shall be applied to the configuration status accounting reports.

G.2.2 Scope and content

The configuration status accounting reports shall provide the information presented in the following sections:

<1> Introduction

The introduction shall describe the purpose and objective of the configuration status accounting reports.

<2> Applicable and reference documents

The configuration status accounting reports shall list the applicable and reference documents in support to the generation of the document

<3> Description

The configuration status accounting reports shall contain information on:

- Documents index and status list
 - document identification;
 - issue and revision;

- issue and revision date;
- title;
- remarks;
- identification of obsolete documents.
- Drawing index and status list
 - drawing identification;
 - issue and revision;
 - issue and revision date;
 - title;
 - remarks;
 - model applicability of the drawing.
- Request for deviation index and status list
 - deviation document number;
 - issue and revision;
 - issue and revision date;
 - title;
 - document or requirement affected;
 - configuration item(s) affected;
 - status of approval.
- Request for waiver index and status list
 - waiver document number;
 - issue and revision;
 - issue and revision date;
 - title;
 - document or requirement affected;
 - NCR originating the waiver;
 - serial number of configuration item(s) affected;
 - status of approval.
- Change proposal (CP) index and status list
 - CP document number;
 - issue and revision;
 - issue and revision date;
 - title;
 - change request originating the change;
 - configuration item(s) affected;
 - status of approval.
- Review item discrepancies (RID) index and status list
 - design review identification;
 - RID identification;
 - title of the discrepancy;
 - affected document number and issue;
 - affected paragraph;
 - RID status;
 - identification of action assigned;

- RID closure date;
- remarks.

G.2.3 Special remarks

None.

(This page is intentionally left blank)

Annex H (normative)

Change request DRD

H.1 DRD identification

H.1.1 Requirement identification and source document

ECSS-M-40B, requirement 5.3.2.3.a.

H.1.2 Purpose and objective

The objective of a change request is to collect the information that formally defines a proposed programme or project change versus the existing requirements.

H.2 Expected response

H.2.1 Response identification

The requirements for document identification contained in ECSS-M-50 shall be applied to the change request.

H.2.2 Scope and content

The change request shall contain the following information:

No.	Data	Description
1	Organization	Identification of the change request originating organization
2	Number	Unique identification and register number
3	Issue	Issue status of the change request
4	Date	Issue date of the change request
5	Project	Project under which the change request is supplied
6	Title	Title of change request
7	Affected item(s)	Identification of the CI(s) or PI(s) (number and name) which are affected by the change request

No.	Data	Description
8	Affected document(s)	Identification of the document(s) to which the change request applies (document number and issue, paragraph or requirement id)
9	Reason for change	Reason why the proposed change has to be made (Rationale)
10	Description of change	Change description, and when requirements are affected, proposed new wording
11	Approval	Names, date and signatures of the relevant authorities
12	Authorization to proceed	Information on the authorization to proceed or the limit of liability, if the change has to be incorporated immediately

H.2.3 Special remarks

None.

Annex I (normative)

Change proposal DRD

I.1 DRD identification

I.1.1 Requirement identification and source document

ECSS-M-40B, requirement 5.3.2.3.b.

I.1.2 Purpose and objective

The objective of the change proposal is to be the vehicle for proposing a major change to an approved baselined data or the business agreement.

I.2 Expected response

I.2.1 Response identification

The requirements for document identification contained in ECSS-M-50 shall be applied to the change proposal.

I.2.2 Scope and content

The change proposal shall contain the following information:

No.	Data	Description
1	Organization	Identification of the change proposal originating organization
2	Number	Unique identification and register number
3	Issue	Issue status of the change proposal
4	Date	Issue date of the change proposal
5	Project	Project under which the change proposal is supplied
6	Change request reference	Change request reference on which the change proposal is supplied
7	Title	Title of change
8	Classification	Recommended classification
9	Effectivity	Recommended introduction point and identification of the application range of the change

No.	Data	Description
10	Change description	Description of the change
11	Affected item(s)	Identification of the CI or PI (number and name) affected by the change proposal
12	Affected document(s)	Identification of the document(s) (e.g. number and issue, paragraph or design data) affected by the change
13	Change reason	Reason for Change; Describe the rationale for the change proposal approval
14	Related factors	Indication on related factors (e.g. interfaces, safety) of the change: performances, interfaces, interchangeability, qualification, reliability, maintainability, safety, electrical and mechanical parameters, material or processes, parts, testing, ground segment, GSE and tooling, user documentation, cost, schedule.
15	Effect	Estimated influences on contract provisions
16	Price	Detailed cost identification and overall summary price of the change
17	Schedule effects	Effects on schedule
18	Limitation of use	Regarding the intended use
19	Initiator approval	Names, date and signatures of the relevant authorities
20	Customer approval	Names, date and signatures of the relevant authorities

1.2.3 Special remarks

None.

Annex J (normative)

Request for deviation DRD

J.1 DRD identification

J.1.1 Requirement identification and source document

ECSS-M-40B, requirement 5.3.2.6.a.

J.1.2 Purpose and objective

The objective of the request for deviation is to be the vehicle for requiring and agreeing the departure from a customer's requirement that is part of an approved configuration baseline.

J.2 Expected response

J.2.1 Response identification

The requirements for document identification contained in ECSS-M-50 shall be applied to the request for deviation.

J.2.2 Scope and content

The request for deviation shall contain the following information:

Id	Data	Description
1	Organization	Identification of the request for deviation originating organization
2	Number	Unique identification and register number
3	Issue	Issue status of the request for deviation
4	Date	Issue date of the request for deviation
5	Classification	Recommended classification (i.e. major or minor)
6	Project	Project under which the nonconforming item is supplied
7	Business agreement	Business agreement identification under which the nonconforming item is supplied
8	Order	Order number under which the nonconforming item is supplied

Id	Data	Description
9	Originator site	Location of the request for deviation originator
10	Item designation	Identification of the nonconforming item per name and number, according to its configuration item data list
11	Affected item(s)	Identification of the CI(s) (number and name) affected by the deviation
12	Effectivity	Effectivity of the deviation by model or serial number
13	Affected document(s)	Identification of the document(s) to which the item does not conform (document number and issue, paragraph or requirement id)
14	Short description	Title or short description of the request for deviation
15	Detailed description	Description of the deviation from the relevant requirement or design feature
16	Reason for request	Reason why the proposed deviation can be accepted (rationale)
17	Adverse effects	Item characteristics affected by the deviation
18	Approval	Decision, names, date and signatures of the relevant authorities

J.2.3 Special remarks

None.

Annex K (normative)

Request for waiver DRD

K.1 DRD identification

K.1.1 Requirement identification and source document

ECSS-M-40B, requirement 5.3.2.6 b.

K.1.2 Purpose and objective:

The objective of the request for waiver is to be the vehicle for requiring and agreeing to the use or the delivery of a product that does not conform to its approved product configuration baseline.

K.2 Expected response

K.2.1 Response identification

The requirements for document identification contained in ECSS-M-50 shall be applied to the request for waiver.

K.2.2 Scope and content

The request for waiver shall contain the following information:

Id	Data	Description
1	Organization	Identification of the request for waiver originating organization
2	Number	Unique identification and register number
3	Issue	Issue status of the request for waiver
4	Date	Issue date of the request for waiver
5	Project	Project under which the nonconforming item is supplied
6	Business agreement	Business agreement identification under which the nonconforming item is supplied
7	Order	Order number under which the nonconforming item is supplied
8	Originator site	Location of the request for waiver originator

Id	Data	Description
9	Item designation	Identification of the nonconforming item per name and number, according to its configuration item data list
10	Affected item(s)	Identification of the CI (number and name) affected by the waiver
11	Effectivity	Model or serial number (or batch / lot number) of the nonconforming item(s)
12	Affected document	Identification of the document(s) (number and issue, paragraph or design data) to which the item does not conform
13	Short description	Title or short description of the request for waiver (consistent with the title of the related nonconformance report)
14	Detailed description	Description of the nonconformity, supported by sketches and attachments as appropriate
15	Reason for request	Reason why the proposed nonconformity can be accepted (Rationale)
16	NCR	Identification number of the nonconformance report related to the request for waiver
17	NRB	Identification of the minutes of meeting of the nonconformance review board which decided to raise the request for waiver
18	Adverse effects	Item characteristics affected by the nonconformity
19	Limitation of use	Regarding the intended use
20	Classification	Major or minor as per the classification criteria
21	Approval	Decision, name, date and signature of the relevant authorities

K.2.3 Special remarks

None.

Annex L (informative)

Configuration item selection

L.1 General

The selection of configuration items (CI) is a management decision based on experience and good judgment. Therefore, this annex exposes the risk in selecting too many or too few items, and provides a check-list to be used to help the selection process.

L.2 Effects of selecting too many configuration items

Too many CIs can result in effects hampering visibility and management rather than improving it. These effects include:

- increased administrative burden in preparing, processing, and status reporting of related documentation, which tends to be multiplied by the number of CIs; or
- increased development time and cost as well as possibly creating an inefficient design.

Possible increase in management effort, difficulties in maintaining coordination and unnecessary generation of paper work or files.

L.3 Effects of selecting too few configuration items

Too few configuration items can result in decreasing management visibility and progress assessment, increasing cost and difficulties in logistics and maintenance.

When the lowest level designated CI is a complex item (e.g. implementing unrelated functions, containing both hardware and software components), the following can result:

- the potential for reuse of the CI, or portions of the CI is diminished;
- re-procurement of the CI and components is complicated;
- potential re-procurement sources are limited;
- formal testing of critical capabilities may be delayed or made more difficult;
- the inability to account for the deployment of a CI whose component parts are disbursed to different locations;
- difficulty in addressing the effectiveness of changes and retrofit actions, particularly when there are different quantities or separately deliverable components;

- increased complexity in managing and accounting for common assemblies and components;
- loss of identity through separation of affected portions of a CI during operational or depot maintenance or modification installation activity;
- inability to control individual, but identical, remove or replace items when CI identification and control is set at too high a level;
- loss of operational use of one function because of maintenance of another function within the same CI.

L.4 Configuration item selection check-list

The following list of questions is proposed to help the selection process of CIs.

If most of the questions can be answered with YES, then the item is a good candidate for being a CI. On the contrary, if most of the questions can be answered with NO, then the item is not a good candidate. If the questions can be answered with approximately equal numbers of YES's and NO's, additional judgment is needed.

1. Is the product critical from a safety, schedule or financial point of view?
2. Will the product require development of a new design or a significant modification to an existing design?
3. Does the product incorporate new or unproven technologies?
4. Does the product have an interface with hardware or software developed under another contract?
5. Is the item required for logistic support or activity?
6. Do all components of the product have common mission, installation and deployment requirements, common testing and acceptance?
7. Does the product have interdependent functions?
8. Does the product have reconfiguration capability?
9. Is it, or does it have the potential (schedule or location) to be designated for separate procurement?
10. Can (or must) the item be independently tested?
11. Is it readily identifiable with respect to size, shape and weight?
12. With respect to form, fit or function, does it interface with other CIs whose configuration is controlled by other entities?
13. Is there a requirement to know the exact configuration and status of changes to it during its life cycle?
14. Does the item have separate mission, training, test, maintenance and support functions, or require separately designated versions for such purposes?

Annex M (informative)

Comparison tables

M.1 Introduction

The following tables provide comparisons of requirements between ECSS-M-40B and the three major CM International Standards, namely:

- ISO 10007:2003, Quality management — Guidelines for configuration management
- ISO/IEC TR 15846:1998, Information technology — Software life cycle processes — Configuration management
- ANSI/EIA-649:2001, ANSI/EIA National Consensus Standard for configuration management

The purpose of these tables is to support the users of the addressed standards in defining any extra effort to comply with ECSS-M-40B.

M.2 ECSS-M-40B vs ISO 10007:2003 comparison table

ECSS-M-40B vs ISO 10007:2003 comparison table				
Clause ECSS-M-40B	Subject	Clause ISO 10007	Subject	Remarks to ISO 10007
1	Scope	1	Scope	Guidance only
2	Normative References	2	Normative reference	
3	Terms, definitions and abbreviations terms	3	Terms and definitions	No acronyms/abbreviations
3.1	Terms and definitions	-	-	
3.1.1	Change control	3.1	Change control	
3.1.2	Class 1 change	-	-	
3.1.3	Class 2 change	-	-	
3.1.4	Configuration	3.3	Configuration	
3.1.5	Configuration baseline	3.4	Configuration baseline	
3.1.6	Configuration control	-	-	
3.1.7	Configuration control board	3.8	Dispositioning authority	
3.1.8	Configuration definition document	.	.	
3.1.9	Configuration document	-	-	
3.1.10	Configuration identification	-	-	
3.1.11	Configuration item	3.5	Configuration item	
3.1.12	Configuration management	3.6	Configuration management	
3.1.13	Configuration status accounting	3.7	Configuration status accounting	
3.1.14	Configuration verification	-	-	
3.1.15	Configured item	-	-	
3.1.16	Departure	3.2	Concession	
3.1.17	Product item	-	-	
3.1.18	Technical description	-	-	
3.2	Abbreviated terms	-	-	
4	Configuration management principles	5	Configuration management processes	

Clause ECSS-M-40B	Subject	Clause ISO 10007	Subject	Remarks to ISO 10007
4.1	Configuration management process and objectives	5.1	General	Same aim but different language
Fig. 1	Configuration management	-	-	
4.2	Management and planning	-	-	
4.2.1	Configuration management plan	5.2	Configuration management planning	Very general
4.2.2	Configuration management interfaces	5.3.1	Product structure and selection of configuration items	
		5.3.2	Documentation of configuration items	
Fig.2	Configuration management interface (inputs)	-	-	
Fig.3	Configuration management interface (outputs)	-	-	
4.3	Implementation of configuration management	4	Configuration management responsibilities	
4.3.1	General	4.1	Responsibilities and authorities	Same aim but not detailed
Fig.4	Implementation of configuration management			
4.3.2	Configuration identification	5.3	Configuration identification	
4.3.2.1	General	5.3.2	Product configuration information	
Fig.5	Configuration identification	-	-	
4.3.2.2	Configuration item	-	-	
4.3.2.3	Selection of configuration items	5.3.1	Product structure and selection of configuration items	
Fig.6	CI product tree structure	-	-	
4.3.2.4	Configuration baseline	5.3.3	Configuration baseline	
4.3.2.5	Identification marking	-	-	
4.3.2.6	Digital file and media identification	-	-	
4.3.3	Configuration control	5.4	Change control	
4.3.3.1	General	5.4.1	General	

Clause ECSS-M-40B	Subject	Clause ISO 10007	Subject	Remarks to ISO 10007
Fig.7	Configuration control	-	-	
4.3.3.2	Change procedure	5.4.2	Initiation, identification and documentation of the need for change	
4.3.3.3	Configuration control board	5.4.4	Disposition of change	
4.3.3.4	Classification of changes and departures	5.4.3	Evaluation of change	
4.3.3.5	Interface control	-	-	
4.3.4	Configuration status accounting	5.5	Configuration status accounting	
4.3.4.1	General	5.5.1/5.5.2	General / Records	
4.3.4.2	As-designed and as-built data list	5.5.3	Reports	
4.3.5	Configuration verification	5.6	Configuration audit	
4.3.6	Configuration management process audit	-	-	
4.3.7	Configuration management approach for operational phase	-	-	
Fig.8	Project phases and baseline definitions	-	-	
5	Configuration management requirements	5	Configuration management processes	
5.1	General	-	-	
5.2	Management and planning	5.2	Configuration management planning	First item, not as detailed
5.2.1	Configuration management plan	5.2	Configuration management planning	Different wording, same aim
5.2.2	Configuration management interfaces	-	-	
5.3	Implementation of configuration management	4	Configuration management responsibilities	
5.3.1	Configuration identification	5.3	Configuration identification	
5.3.1.1	Product tree	5.3.1	Product structure and selection of configuration items	
5.3.1.2	Configuration item	-	-	

Clause ECSS-M-40B	Subject	Clause ISO 10007	Subject	Remarks to ISO 10007
5.3.1.3	Configuration item selection	5.3.1	Product structure and selection of configuration items	
5.3.1.4	Configuration baseline	5.3.3	Configuration baseline	
5.3.1.5	Baseline establishment	5.3.3	Configuration baseline	Very general
5.3.1.6	Identification marking	-	-	
5.3.1.7	Digital file and media identification	-	-	
5.3.2	Configuration control	5.4	Change control	
5.3.2.1	Change procedure	5.4.2	Initiation, identification and documentation of the need for change	
5.3.2.2	Classification of changes and departures	5.4.3	Evaluation of change	
5.3.2.3	Initiation of change	5.4.1	General	
5.3.2.4	Change assessment	5.4.3	Evaluation of change	
5.3.2.5	Change disposition	5.4.4	Disposition of change	
5.3.2.6	Departures from configuration baseline	-	-	
5.3.2.7	Baseline and documentation update	5.4.5	Implementation and verification of change	
5.3.2.8	Interface control	.	.	
5.3.3	Configuration status accounting	5.5	Configuration status accounting	
5.3.3.1	General	5.5.1/5.5.2	General / Records	
5.3.3.2	As-designed data list	5.5.3	Reports	
5.3.3.3	As-built data list	5.5.3	Reports	
5.3.4	Configuration verification	5.6	Configuration audit	
5.3.4.1	Verification of the product configuration definition	-	-	
5.3.4.2	Verification of the product configuration	5.6	Configuration audit	
5.3.5	Audit of the configuration management system	-	-	

Clause ECSS-M-40B	Subject	Clause ISO 10007	Subject	Remarks to ISO 10007
5.3.6	Configuration management approach for operational phase	-	-	
Annex A	Configuration management plan DRD	Annex A	Structure and content of configuration management plan	Only informative annex
Annex B	Product tree DRD	-	-	
Annex C	Configuration item list DRD	-	-	
Annex D	Configuration item data list DRD	-	-	
Annex E	As-built configuration list DRD	-	-	
Annex F	Software configuration file DRD	-	-	
Annex G	Configuration status accounting reports DRD	-	-	
Annex H	Change request DRD	-	-	
Annex I	Change proposal DRD	-	-	
Annex J	Request for deviation DRD	-	-	
Annex K	Request for waiver DRD	-	-	
Annex L	Configuration item selection	5.3.1	Product structure and selection of configuration items	Very general

M.3 ECSS-M-40B vs ISO/IEC TR 15846:1998 comparison table

ECSS-M-40B VS ISO/IEC TR 15846 comparison table					
Clause ECSS-M-40B	Subject	Clause ISO 15846	Subject	Remarks to ISO 15846	
1	Scope	1	Scope		
2	Normative references	3	Normative references		
3	Terms, definitions and abbreviations terms	-	-		
3.1	Terms and definitions	4	Definitions		
3.1.1	Change control	-	-		
3.1.2	Class 1 change	-	-		
3.1.3	Class 2 change	-	-		
3.1.4	Configuration	-	-		
3.1.5	Configuration baseline	-	-		
3.1.6	Configuration control	-	-		
3.1.7	Configuration control board	4.2	Change authority		
3.1.8	Configuration definition document	-	-		
3.1.9	Configuration document	-	-		
3.1.10	Configuration identification	-	-		
3.1.11	Configuration item	-	-		
3.1.12	Configuration management	-	-		
3.1.13	Configuration status accounting	-	-		
3.1.14	Configuration verification	-	-		
3.1.15	Configured item	-	-		
3.1.16	Departure	-	-		
3.1.17	Product item	-	-		
3.1.18	Technical description	-	-		

Clause ECSS-M-40B	Subject	Clause ISO 15846	Subject	Remarks to ISO 15846
3.2	Abbreviated terms	5.1	Abbreviations and acronyms	
4	Configuration management principles	-	-	
4.1	Configuration management process and objectives	Introduction	Implementation of CM process, benefits	
Fig. 1	Configuration management	-	-	
4.2	Management and planning	6.2	Planning	
4.2.1	Configuration management plan	6.2	Planning	
4.2.2	Configuration management interfaces	-	-	
Fig.2	Configuration management interface (inputs)	-	-	
Fig.3	Configuration management interface (outputs)	-	-	
4.3	Implementation of configuration management	6	SCM process implementation	
4.3.1	General	6	SCM process implementation	
Fig.4	Implementation of configuration management	-	-	
4.3.2	Configuration identification	7	Software configuration identification	
4.3.2.1	General	7	Software configuration identification	
Fig.5	Configuration identification	-	-	
4.3.2.2	Configuration item	7.1	Identifying SCIs	Very general
4.3.2.3	Selection of configuration items	6.1.4	Criteria for selection of SCIs	
Fig.6	CI product tree structure	-	-	

Clause ECSS-M-40B	Subject	Clause ISO 15846	Subject	Remarks to ISO 15846
4.3.2.4	Configuration baseline	6.1.5	Defining the outcomes from the SCM process	
4.3.2.5	Identification marking	7.2	Identifying software configuration baselines	
4.3.2.6	Digital file and media identification	6.1.5b	Defining the outcomes from the SCM process	
4.3.3	Configuration control	11.4	Packaging	
4.3.3.1	General	8	Software configuration control	
Fig.7	Configuration control	8	Software configuration control	
4.3.3.2	Change procedure	-	-	
4.3.3.3	Configuration control board	8.1	Proposing changes	Very general
4.3.3.4	Classification of changes and departures	8.2	Evaluating the impacts of proposed changes	
4.3.3.5	Interface control	8.4	Communicating the disposition	
4.3.4	Configuration status accounting	-	-	
4.3.4.1	General	12	Interface control	
4.3.4.2	As-designed and as-built data list	9	Software configuration status accounting	
4.3.5	Configuration verification	9	Software configuration status accounting	
4.3.6	Configuration management process audit	9.3	Reporting status accounting records	
4.3.7	Configuration management approach for operational phase	10	Software configuration evaluation	
Fig.8	Project phases and baseline definitions	-	-	

Clause ECSS-M-40B	Subject	Clause ISO 15846	Subject	Remarks to ISO 15846
5	Configuration management requirements	-	-	
5.1	General	-	-	
5.2	Management and planning	6.2	Planning	
5.2.1	Configuration management plan	6.2	Planning	
5.2.2	Configuration management interfaces	-	-	
5.3	Implementation of configuration management	6	SCM process implementation	
5.3.1	Configuration identification	7	Software configuration identification	
5.3.1.1	Product tree	-	-	
5.3.1.2	Configuration item	7.1	Identifying SCIs	Wording limited to identification only
5.3.1.3	Configuration item selection	6.1.4	Criteria for selection of SCIs	Different approach
5.3.1.4	Configuration baseline	6.1.5	Defining the outcomes from the SCM process	
		7.2	Identifying software configuration baselines	
5.3.1.5	Baseline establishment	7.4	Advancement status	Very general
5.3.1.6	Identification marking	-	-	
5.3.1.7	Digital file and media identification	11.4	Packaging	
5.3.2	Configuration control	8	Software configuration control	
5.3.2.1	Change procedure	8.1	Proposing changes	
5.3.2.2	Classification of changes and departures	-	-	
5.3.2.3	Initiation of change	-	-	
5.3.2.4	Change assessment	8.2	Evaluating the impacts of proposed changes	

Clause ECSS-M-40B	Subject	Clause ISO 15846	Subject	Remarks to ISO 15846
5.3.2.5	Change disposition	8.4	Communicating the disposition	
5.3.2.6	Departures from configuration baseline	-	-	
5.3.2.7	Baseline and documentation update date	8.3	Implementing the changes	
5.3.2.8	Interface control	8.5	Closing the changes	
5.3.3	Configuration status accounting	12	Interface control	
5.3.3.1	General	9	Software configuration status accounting	
5.3.3.2	As-designed data list	9	Software configuration status accounting	
5.3.3.3	As-built data list	9.2	Tracing changes	
5.3.4	Configuration verification	9.3	Reporting status accounting records	
5.3.4.1	Verification of the product configuration definition	-	-	
5.3.4.2	Verification of the product configuration	10	Software configuration evaluation	
5.3.5	Audit of the configuration management system	10	Software configuration evaluation	
5.3.6	Configuration management approach for operational phase	-	-	
Annex A	Configuration management plan DRD	-	-	
Annex B	Product tree DRD	-	-	
Annex C	Configuration item list DRD	-	-	
Annex D	Configuration item data list DRD	-	-	
Annex E	As-built configuration list DRD	-	-	
Annex F	Software configuration file DRD	-	-	

Clause ECSS-M-40B	Subject	Clause ISO 15846	Subject	Remarks to ISO 15846
Annex G	Configuration status accounting reports DRD	-	-	
Annex H	Change request DRD	-	-	
Annex I	Change proposal DRD	-	-	
Annex J	Request for deviation DRD	-	-	
Annex K	Request for waiver DRD	-	-	
Annex L	Configuration item selection	-	-	

M.4 ECSS-M-40B vs EIA-649A:2001 comparison table

ECSS-M-40B vs EIA-649A comparison table					
Clause ECSS-M-40B	Subject	Clause EIA-649A	Subject	Remarks to EIA-649A	
1	Scope	1	Scope	More detailed	
2	Normative references	2	References		
3	Terms, definitions and abbreviations terms	-	-		
3.1	Terms and definitions	Table 2 3	Common aliases Definitions	More detailed but ECSS-M-40 refers also to ECSS-P-001	
3.1.1	Change control	-	-		
3.1.2	Class 1 change	-	Configuration change	Generic definition	
3.1.3	Class 2 change	-	Configuration change	Generic definition	
3.1.4	Configuration	-	Configuration		
3.1.5	Configuration baseline	-	Configuration baseline		
3.1.6	Configuration control	-	Configuration change management		
3.1.7	Configuration control board	-	-		
3.1.8	Configuration definition document	-	-		
3.1.9	Configuration document	-	Document	Generic definition of document	
3.1.10	Configuration identification	-	Configuration identification		
3.1.11	Configuration item	-	-		
3.1.12	Configuration management	-	Configuration management		
3.1.13	Configuration status accounting	-	Configuration status accounting		
3.1.14	Configuration verification	-	Configuration verification		
3.1.15	Configured item	-	-		
3.1.16	Departure	-	-		
3.1.17	Product item	-	Product identifier	More relevant to product	
3.1.18	Technical description	-	-		
3.2	Abbreviated terms	4	Symbols and abbreviations		

Clause ECSS-M-40B	Subject	Clause EIA-649A	Subject	Remarks to EIA-649A
4	Configuration management principles	5	CM functions and principles	
4.1	Configuration management process and objectives	5	CM functions and principles	
Fig. 1	Configuration management	Fig.1	CM functions	
4.2	Management and planning	5.1	Configuration management planning and management	Including sub-para's
4.2.1	Configuration management plan	5.1.2	Document CM Planning	
4.2.2	Configuration management interfaces	-	-	
Fig.2	Configuration management interface (inputs)	-	-	
Fig.3	Configuration management interface (outputs)	-	-	
4.3	Implementation of configuration management	-	-	
4.3.1	General	5.1	Configuration management planning and management	Including sub-para's
Fig.4	Implementation of configuration management	5.1.1	Identify context and environment	
4.3.2	Configuration identification	-	-	
4.3.2.1	General	5.2 5.2.3.2.1 5.2.3.2.2 5.2.3.2.3	Configuration identification Product identifiers Identifying individual units of a product Identifying groups of units of a product	
Fig.5	Configuration identification	Fig.2	Product configuration information	Not related to the entire activity but only to a part of it
4.3.2.2	Configuration item	5.2.3.1	Identifying products, and product configuration	

Clause ECSS-M-40B	Subject	Clause EIA-649A	Subject	Remarks to EIA-649A
4.3.2.3	Selection of configuration items	5.2.2	Product structure	Focused on product
Fig.6	CI product tree structure	Fig.3	Example of product structure	
4.3.2.4	Configuration baseline	5.2.4	Configuration baselines	
4.3.2.5	Identification marking	5.2.3.2	Identifying product	Including sub-para's
4.3.2.6	Digital file and media identification	5.2.3.2	Identifying product	Including sub-para's
4.3.3	Configuration control	-	-	
4.3.3.1	General	5.3	Configuration change management	
Fig.7	Configuration control	Fig.4	Configuration change management process model	
4.3.3.2	Change procedure	5.3.1 5.3.1.1	Request for change Change initiation	
4.3.3.3	Configuration control board	5.3.1.2	Change evaluation and impact coordination	
4.3.3.4	Classification of changes and departures	5.3.1.1.2	Classifying changes	
4.3.3.5	Interface control	5.2.5	Interface control	
4.3.4	Configuration status accounting	-	-	
4.3.4.1	General	5.4	Configuration status accounting	Very generic
4.3.4.2	As-designed and as-built data list	-	-	
4.3.5	Configuration verification	5.5	Configuration verification and audit	
4.3.6	Configuration management process audit	5.5.3	Configuration management process surveillance	
4.3.7	Configuration management approach for operational phase	-	-	
Fig.8	Project phases and baseline definitions	-	-	
5	Configuration management requirements	-	-	

Clause ECSS-M-40B	Subject	Clause EIA-649A	Subject	Remarks to EIA-649A
5.1	General	-	-	
5.2	Management and planning	5.1	Configuration management planning and management	Including sub-para's
5.2.1	Configuration management plan	5.1.2	Document CM planning	
5.2.2	Configuration management interfaces	-	-	
5.3	Implementation of configuration management	5.1.1	Identify context and environment	
5.3.1	Configuration identification	-	-	
5.3.1.1	Product tree	5.2.2	Product structure	
5.3.1.2	Configuration item	5.2.3.1	Identifying products, and product configuration	
5.3.1.3	Configuration item selection	-	-	
5.3.1.4	Configuration baseline	5.2.4	Configuration baselines	
5.3.1.5	Baseline establishment	5.2.4	Configuration baselines	
5.3.1.6	Identification marking	5.2.3.2	Identifying product	
5.3.1.7	Digital file and media identification	5.2.3.2	Identifying product	
5.3.2	Configuration control	5.3	Configuration change management	
5.3.2.1	Change procedure	5.3.1 5.3.1.1	Request for change Change initiation	
5.3.2.2	Classification of changes and departures	5.3.1.1.2	Classifying changes	
5.3.2.3	Initiation of change	5.3.1.1	Change initiation	
5.3.2.4	Change assessment	5.3.1.2 5.3.1.2.1	Change evaluation and impact coordination Change impact assessment	
5.3.2.5	Change disposition	5.3.1.3.1	Change implementation	
5.3.2.6	Departures from configuration baseline	5.3.2	Configuration change management applied to request for variances	

Clause ECSS-M-40B	Subject	Clause EIA-649A	Subject	Remarks to EIA-649A
5.3.2.7	Baseline and documentation update	5.3.1.3.2	Change verification	
5.3.2.8	Interface control	5.2.5	Interface control	
5.3.3	Configuration status accounting	-	-	
5.3.3.1	General	5.4	Configuration status accounting	Very generic
5.3.3.2	As-designed data list	5.4.1	CSA information	
5.3.3.3	As-built data list	5.4.1	CSA information	
5.3.4	Configuration verification	5.5	Configuration verification and audit	
5.3.4.1	Verification of the product configuration definition	5.5.2	Product definition information verification	
5.3.4.2	Verification of the product configuration	5.5 5.5.1	Configuration verification and audit Product performance attribute verification	
5.3.5	Audit of the configuration management system	5.5.5	Configuration management process surveillance	
5.3.6	Configuration management approach for operational phase	-	-	
Annex A	Configuration management plan DRD	-	-	
Annex B	Product tree DRD	-	-	
Annex C	Configuration item list DRD	-	-	
Annex D	Configuration item data list DRD	-	-	
Annex E	As-built configuration list DRD	-	-	
Annex F	Software configuration file DRD	-	-	
Annex G	Configuration status accounting reports DRD	-	-	
Annex H	Change request DRD	-	-	
Annex I	Change proposal DRD	-	-	
Annex J	Request for deviation DRD	-	-	

Clause ECSS-M-40B	Subject	Clause EIA-649A	Subject	Remarks to EIA-649A
Annex K	Request for waiver DRD	-	-	
Annex L	Configuration item selection	-	-	

Bibliography

- ECSS-M-00-02A, *Space project management — Tailoring of space standards.*
- ECSS-M-30, *Space project management — Project phasing and planning.*
- ECSS-M-60, *Space project management — Cost and schedule management.*
- ECSS-M-70, *Space project management — Integrated logistic support.*
- ECSS-Q-20, *Space product assurance — Quality assurance.*
- ISO 10007:2003, *Quality management — Guidelines for configuration management.*
- ISO/IEC TR 15846:1998, *Information technology - Software life cycle processes - Configuration management.*
- ASME Y 14.100-2000, *Engineering drawing practices.*
- ANSI/EIA-649:2001, *ANSI/EIA National Consensus Standard for configuration management.*

(This page is intentionally left blank)

ECSS Change Request / Document Improvement Proposal

A Change Request / Document Improvement Proposal for an ECSS Standards may be submitted to the ECSS Secretariat at any time after publication of the standard using the form presented below.

This form can be downloaded in a MS Word format from the ECSS Website (www.ecss.nl, in the menus: Standards - ECSS forms).



ECSS Change Request / Document Improvement Proposal

1. Originator's name: Organization: e-mail:			2. ECSS Document number: 3. Date:	
4. Number.	5. Location of deficiency clause page (e.g. 3.1 14)	6. Changes	7. Justification	8. Disposition

Filling instructions:

1. **Originator's name** - Insert the originator's name and address
2. **ECSS Document number** - Insert the complete ECSS reference number (e.g. ECSS-M-00B)
3. **Date** - Insert current date
4. **Number** - Insert originator's numbering of CR/DIP (*optional*)
5. **Location** - Insert clause, table or figure number and page number where deficiency was identified
6. **Changes** - Identify any improvement proposed, being as detailed as possible
7. **Justification** - Describe the purpose, reasons and benefits of the proposed change
8. **Disposition** - not to be filled in (*entered by relevant ECSS Panel*)

Once completed please send the CR/DIP via e-mail to: ecss-secretariat@esa.int

(This page is intentionally left blank)